

GE25-KRR-B-2C INA

Insert bearings

TYPE: Ball bearings, Radial insert bearings, With eccentric locking collar, Spherical outer ring, Seals on both side, R seal, relubrication, flinger shields

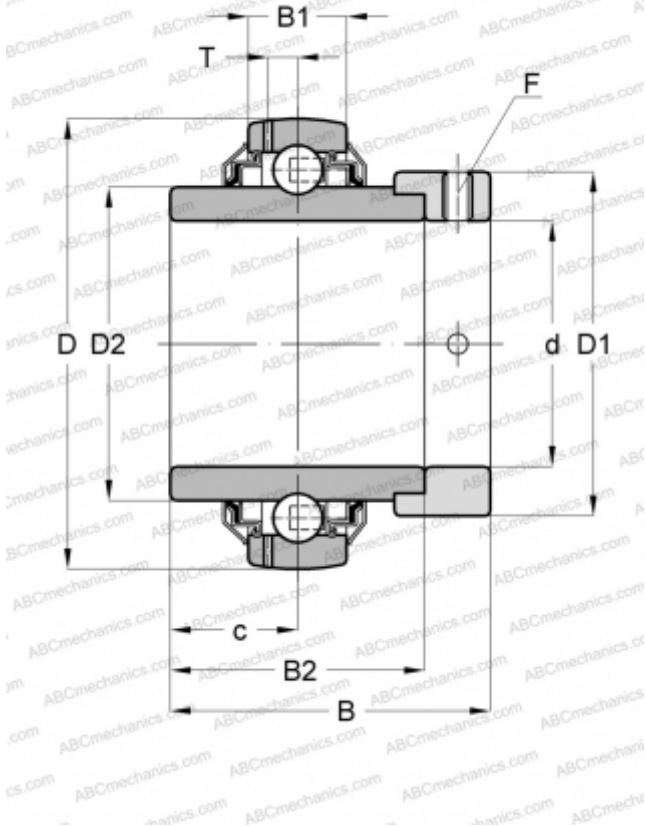

Technical specification

DIMENSIONS, MM

d	25,000
D	52,000
D1	37,500
B	44,500
B1	15,000
B2	34,900
c	17,500
T	3,900
F	3

MANUFACTURER

[INA](#)

CALCULATION DATA

Basic dynamic load rating, C	14,000 kN
Basic static load rating, Co	7,800 kN
Operating temperature min	-20 °C
Operating temperature max	120 °C

REPLACES

GE25-XL-KRR-B-2C