

UGW 201-8+ER ASAHI

Insert bearings

TYPE: Ball bearings, Radial insert bearings, With eccentric locking collar, Spherical outer ring, Seals on both side, R seal, relubrication, inch size

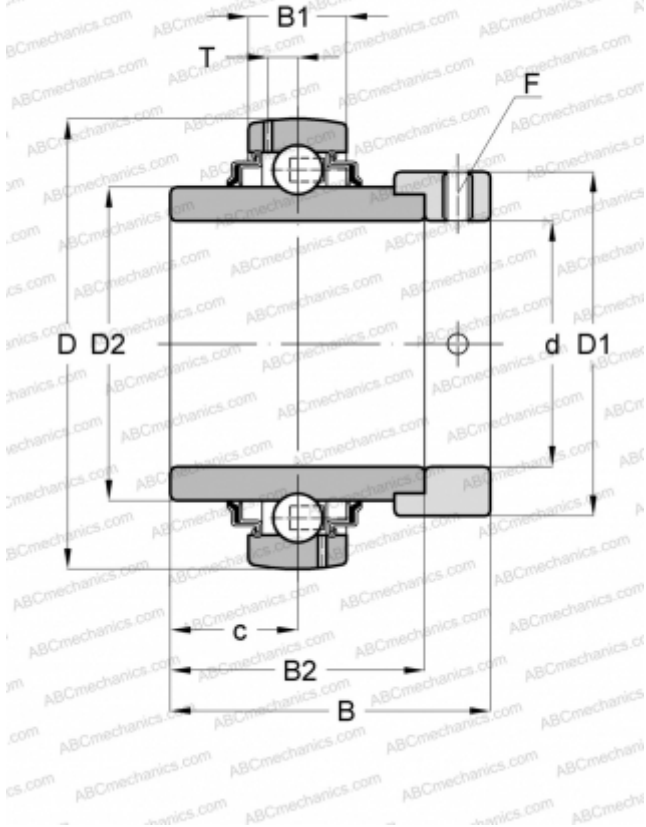

Technical specification

DIMENSIONS, MM

d	12,700
D	40,000
D1	28,575
B	37,300
B1	15,011
B2	27,780
c	5,953
T	3,988
F	1/4-28

MANUFACTURER

[ASAHI](#)

INTERCHANGE

ABC

[UGW 201-8+ER](#)