

UK 205 + H2305 ABC

Insert bearings

TYPE: Ball bearings, Radial insert bearings, With adapter sleeve, Spherical outer ring, Seals on both side, RSR seal, relubrication

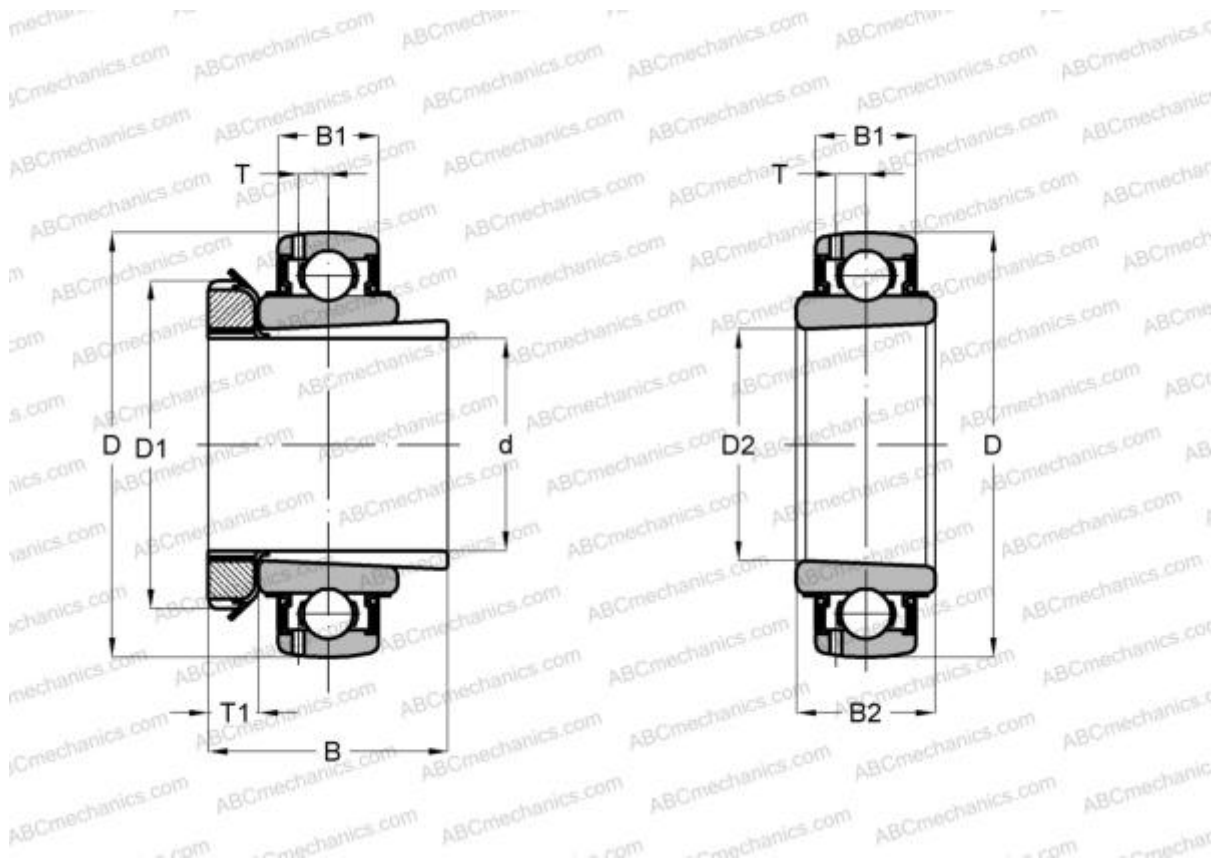

Technical specification

DIMENSIONS, MM

d	20,000
D	52,000
D1	38,000
D2	25,000
B	35,000
B1	17,000
B2	23,000
T	4,500
T1	8,000

MANUFACTURER [ABC](#)

INTERCHANGE

SKF	YSA 205-2FK
ASAHI	UK 205 + H2305
FKL	LK 205 2F

INTERCHANGE

SNR	UK205+H
SLB	UK205
FYH	UK 205
NTN	UK 205 D1