

YSA 205-2FK SKF

Insert bearings

TYPE: Ball bearings, Radial insert bearings, With adapter sleeve, Spherical outer ring, Seals on both side, RSR seal, relubrication

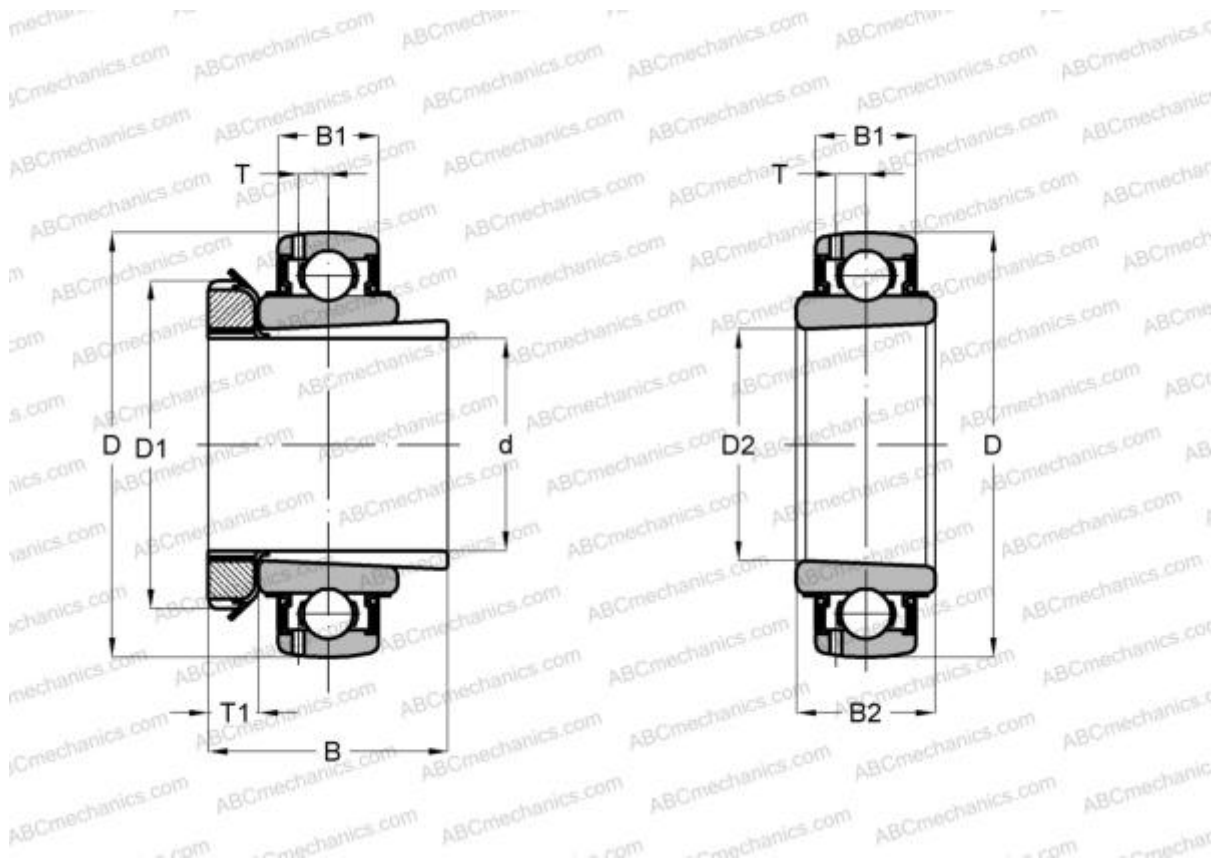

Technical specification

DIMENSIONS, MM

d	20,000
D	52,000
D1	38,000
B	35,000
B1	15,000
B2	24,000

MANUFACTURER

[SKF](#)

INTERCHANGE

ABC	UK 205 + H2305
ASAHI	UK 205 + H2305
FKL	LK 205 2F
SNR	UK205+H
SLB	UK205
FYH	UK 205

INTERCHANGE

NTN [UK 205 D1](#)

CALCULATION DATA

Basic dynamic load rating, C	14,000 kN
Basic static load rating, Co	7,800 kN
Fatigue load limit, Pu	0,335 kN
Limiting speed	7000 r/min



ASSOCIATED PRODUCTS

H 2305

