

YSA 208-2FK SKF

Insert bearings

TYPE: Ball bearings, Radial insert bearings, With adapter sleeve, Spherical outer ring, Seals on both side, RSR seal, relubrication

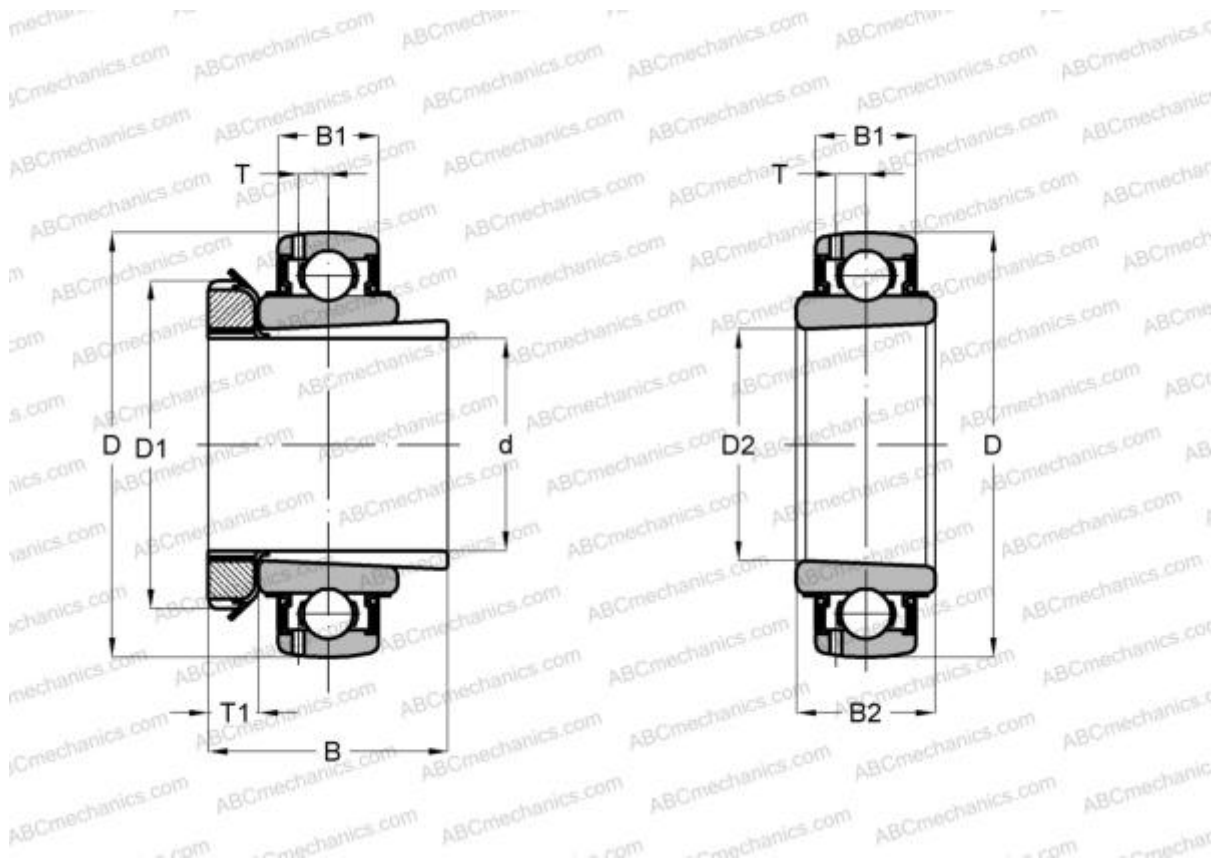

Technical specification

DIMENSIONS, MM

d	35,000
D	80,000
D1	58,000
B	46,000
B1	21,000
B2	33,900

MANUFACTURER

[SKF](#)

INTERCHANGE

ABC	UK 208 + H2308
ASAHI	UK 208 + H2308
FKL	LK 208 2F
SNR	UK208+H
SLB	UK208
FYH	UK 208

INTERCHANGE

NTN [UK 208 D1](#)

CALCULATION DATA

Basic dynamic load rating, C	30,700 kN
Basic static load rating, Co	19,000 kN
Fatigue load limit, Pu	0,800 kN
Limiting speed	4800 r/min



ASSOCIATED PRODUCTS

H 2308

