

KHR 203 AE ABC

Insert bearings

TYPE: Ball bearings, Radial insert bearings, With eccentric locking collar, Cylindrical outer ring, Seals on both side, P seal, without re-lubrication

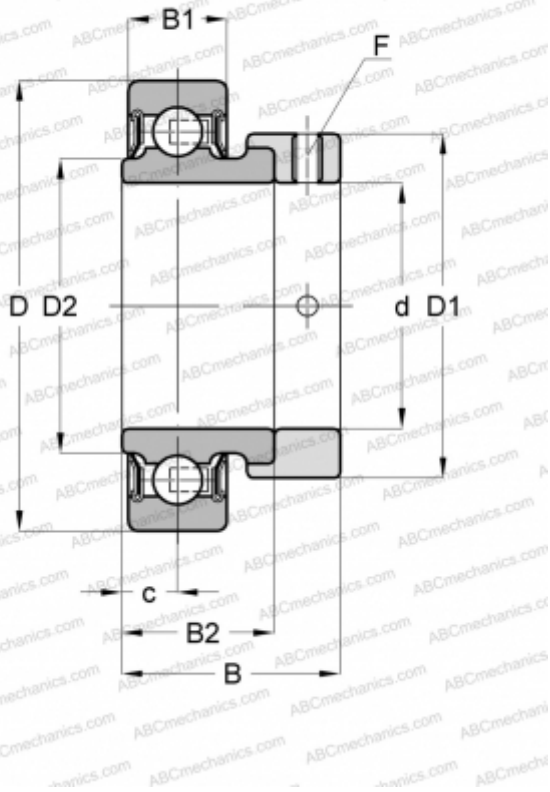

Technical specification

DIMENSIONS, MM

d	17,000
D	40,000
D1	28,600
B	28,600
B1	12,000
B2	19,100
c	6,500

MANUFACTURER

[ABC](#)

INTERCHANGE

INA

[RAE17-NPP-FA106](#)

ASAHI

[KHR 203 AE](#)