

RAE20-NPP-NR INA

Insert bearings

TYPE: Ball bearings, Radial insert bearings, With eccentric locking collar, Cylindrical outer ring, snap ring, Seals on both side, with inner ring extended at one side

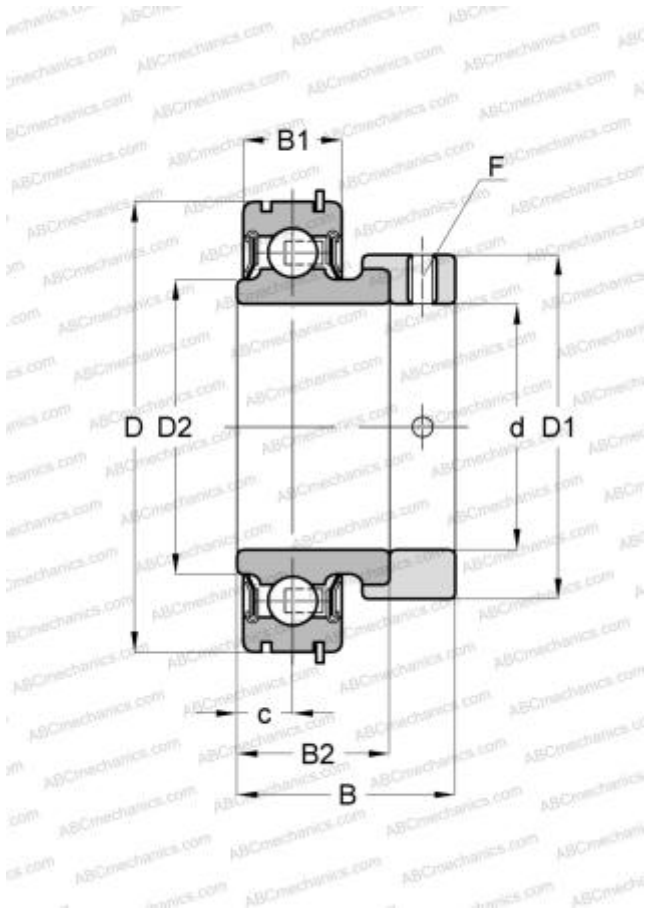

Technical specification

DIMENSIONS, MM

d	20,000
D	47,000
D1	33,000
D2	26,900
B	31,000
B1	14,000
B2	21,400
c	7,500
F	3

MANUFACTURER

[INA](#)

INTERCHANGE

ABC	CES204
SNR	CES204

CALCULATION DATA

Basic dynamic load rating, C	12,800 kN
Basic static load rating, Co	6,600 kN
Operating temperature min	-20 °C
Operating temperature max	120 °C

REPLACES

RAE20-XL-NPP-NR