

CES205 ABC

Insert bearings

TYPE: Ball bearings, Radial insert bearings, With eccentric locking collar, Cylindrical outer ring, snap ring, Seals on both side, with inner ring extended at one side

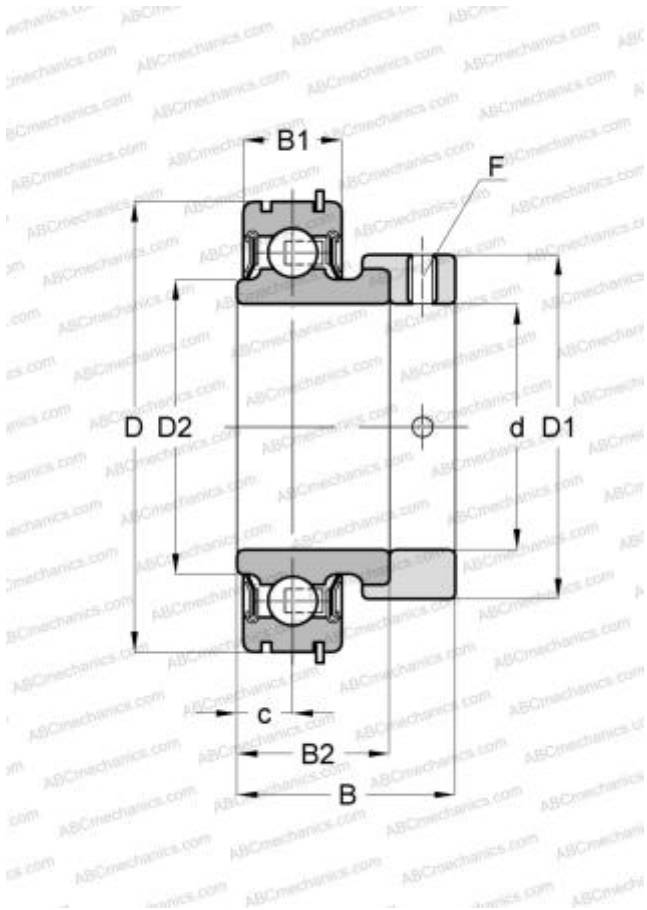

Technical specification

DIMENSIONS, MM

d	25,000
D	52,000
D1	38,100
B	31,000
B1	15,000
B2	21,500
c	7,500
F	M6x1

MANUFACTURER

[ABC](#)

INTERCHANGE

INA	RAE25-NPP-NR
SNR	CES205