

CES205 SNR

Insert bearings

TYPE: Ball bearings, Radial insert bearings, With eccentric locking collar, Cylindrical outer ring, snap ring, Seals on both side, with inner ring extended at one side

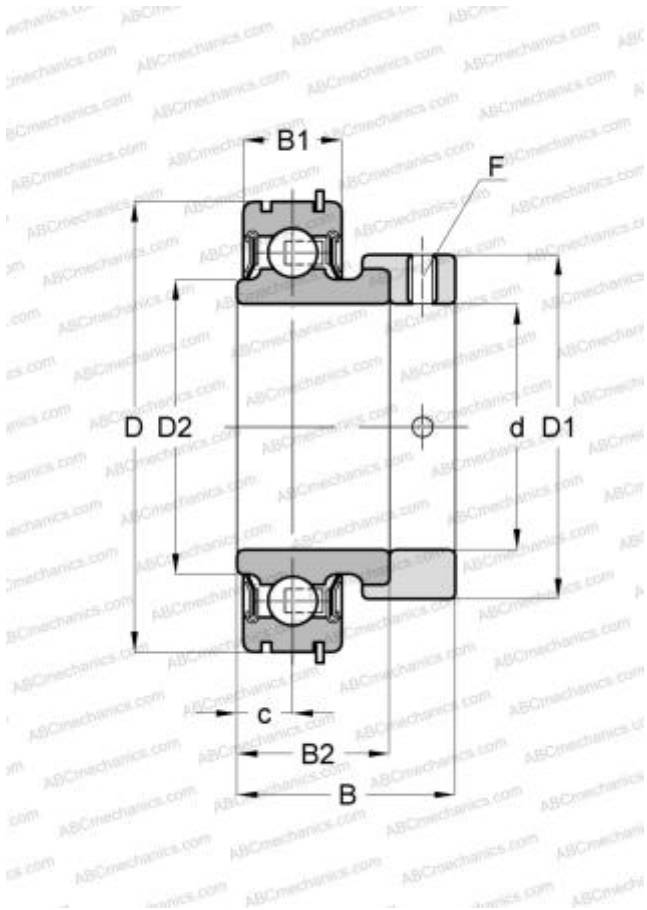

Technical specification

DIMENSIONS, MM

d	25,000
D	52,000
D1	38,100
B	31,000
B1	15,000
B2	21,500
c	7,500
F	M6x1

MANUFACTURER

[SNR](#)

INTERCHANGE

ABC	CES205
INA	RAE25-NPP-NR

CALCULATION DATA

Basic dynamic load rating, C	14,000 kN
Basic static load rating, Co	7,880 kN
Operating temperature min	-20 °C
Operating temperature max	110 °C