

CES206 ABC

Insert bearings

TYPE: Ball bearings, Radial insert bearings, With eccentric locking collar, Cylindrical outer ring, snap ring, Seals on both side, with inner ring extended at one side

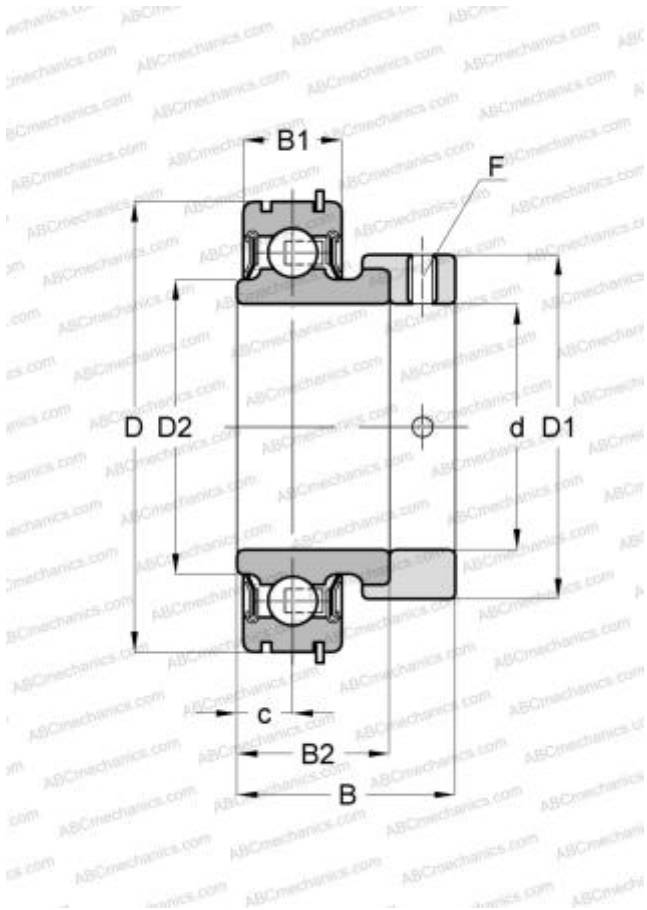

Technical specification

DIMENSIONS, MM

d	30,000
D	62,000
D1	44,500
B	35,700
B1	16,000
B2	23,800
c	8,000
F	M6x1

MANUFACTURER

[ABC](#)

INTERCHANGE

INA	RAE30-NPP-NR
SNR	CES206