

CES207 ABC

Insert bearings

TYPE: Ball bearings, Radial insert bearings, With eccentric locking collar, Cylindrical outer ring, snap ring, Seals on both side, with inner ring extended at one side

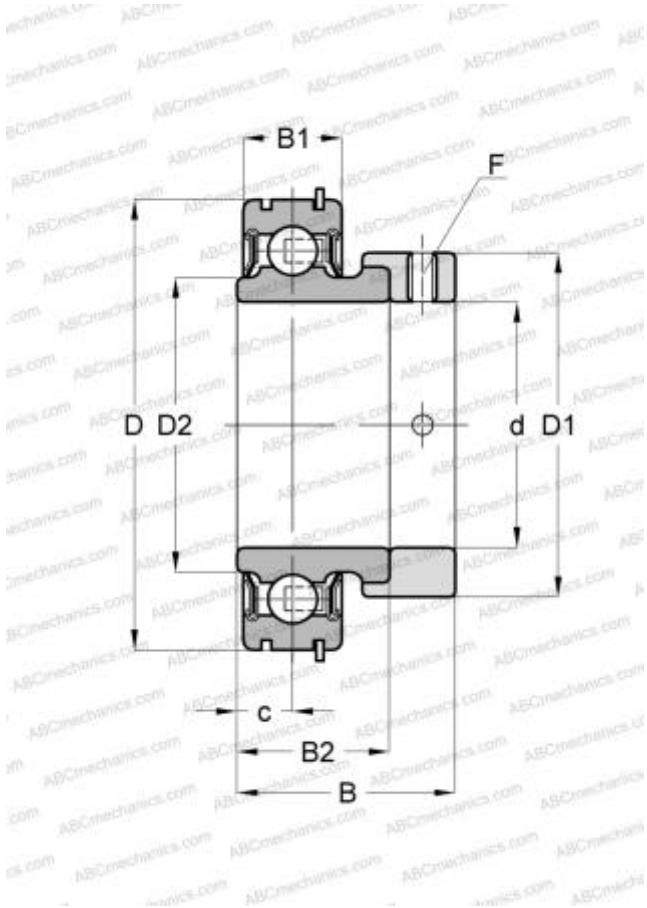

Technical specification

DIMENSIONS, MM

d	35,000
D	72,000
D1	55,600
B	38,900
B1	17,000
B2	25,400
c	8,500
F	M8x1

MANUFACTURER

[ABC](#)

INTERCHANGE

INA	RAE35-NPP-NR
SNR	CES207