

## CES205-15 SNR

Insert bearings

TYPE: Ball bearings, Radial insert bearings, With eccentric locking collar, Cylindrical outer ring, snap ring, Seals on both side, with inner ring extended at one side, inch size

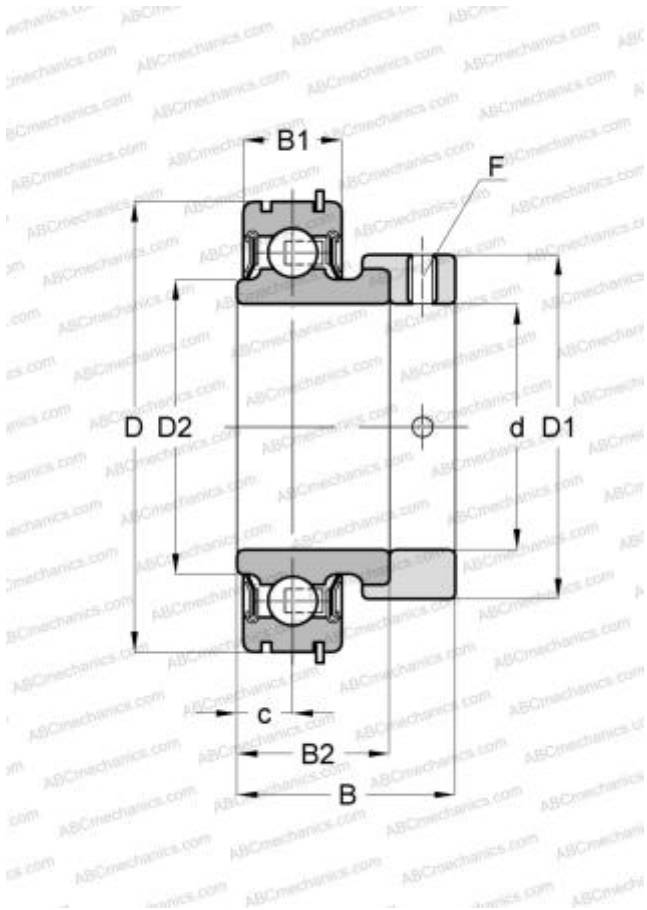

### Technical specification

#### DIMENSIONS, MM

d	23,813
D	52,000
D1	38,100
B	31,000
B1	15,000
B2	21,500
c	7,500
F	1/4-28UNF

#### MANUFACTURER

[SNR](#)

#### INTERCHANGE

ABC

[CES205-15](#)

#### CALCULATION DATA

Basic dynamic load rating, C	14,000 kN
Basic static load rating, Co	7,880 kN
Operating temperature min	-20 °C
Operating temperature max	110 °C