

CES205-16 SNR

Insert bearings

TYPE: Ball bearings, Radial insert bearings, With eccentric locking collar, Cylindrical outer ring, snap ring, Seals on both side, with inner ring extended at one side, inch size

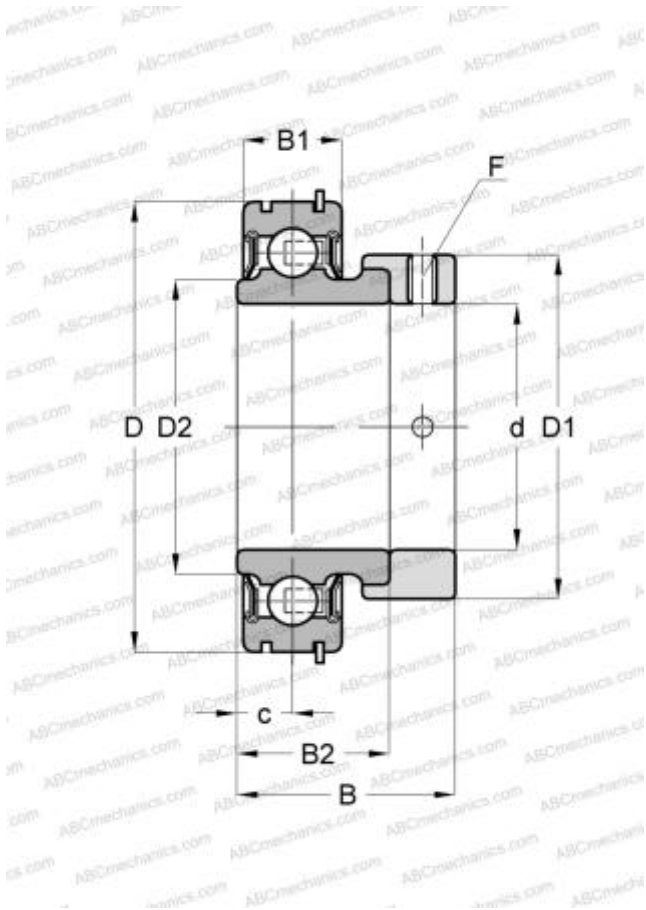

Technical specification

DIMENSIONS, MM

d	25,400
D	52,000
D1	38,100
B	31,000
B1	15,000
B2	21,500
c	7,500
F	1/4-28UNF

MANUFACTURER

[SNR](#)

INTERCHANGE

ABC

[CES205-16](#)

CALCULATION DATA

Basic dynamic load rating, C	14,000 kN
Basic static load rating, Co	7,880 kN
Operating temperature min	-20 °C
Operating temperature max	110 °C