

## CEX204 SNR

Insert bearings

TYPE: Ball bearings, Radial insert bearings, With eccentric locking collar, Cylindrical outer ring, snap ring, Seals on both side, relubrication

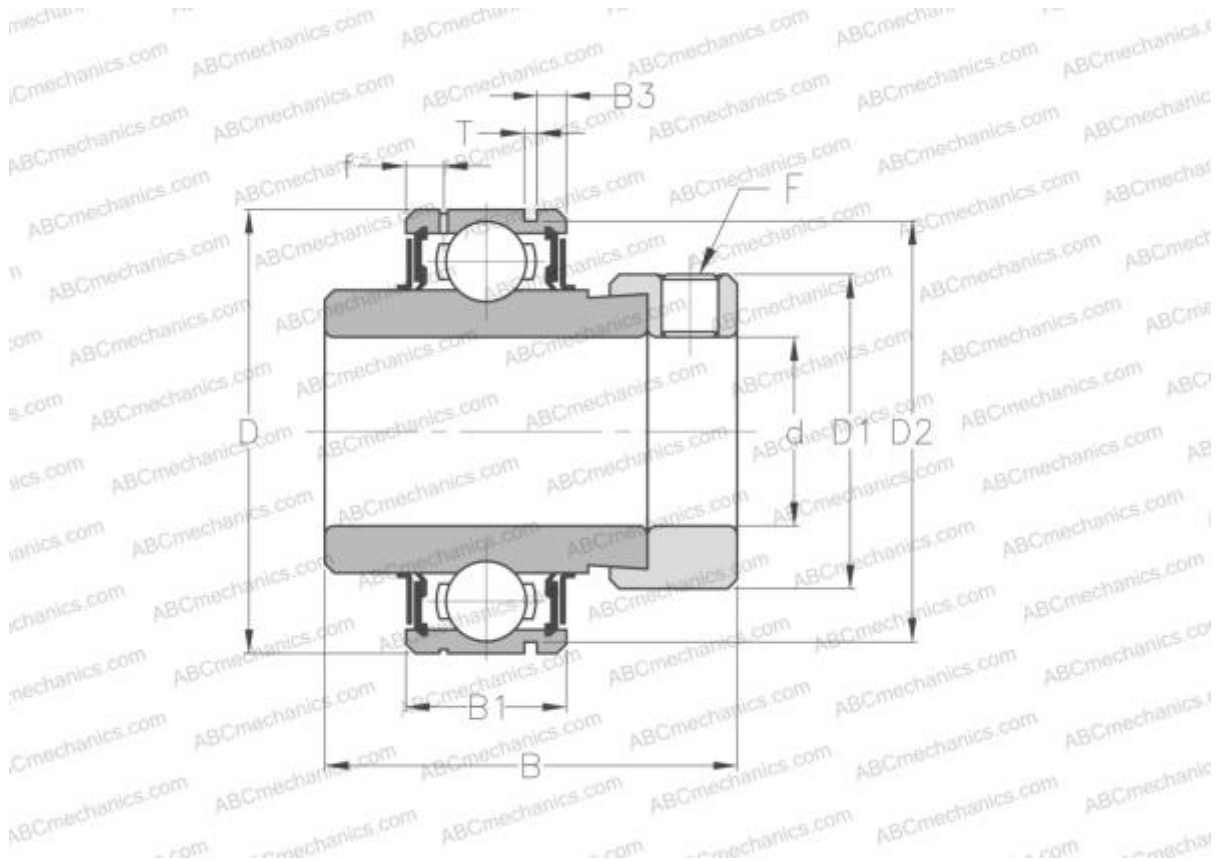

### Technical specification

#### DIMENSIONS, MM

d	20,000
D	47,000
D1	33,300
B	43,700
B1	17,000
B2	34,200
c	17,100
F	M6x1

#### CALCULATION DATA

Operating temperature min	-20 °C
Operating temperature max	110 °C

#### MANUFACTURER

[SNR](#)

#### INTERCHANGE

ABC	<a href="#">CEX204</a>
-----	------------------------

#### CALCULATION DATA

Basic dynamic load rating, C	12,800 kN
Basic static load rating, Co	6,650 kN