

CEX205 SNR

Insert bearings

TYPE: Ball bearings, Radial insert bearings, With eccentric locking collar, Cylindrical outer ring, snap ring, Seals on both side, relubrication

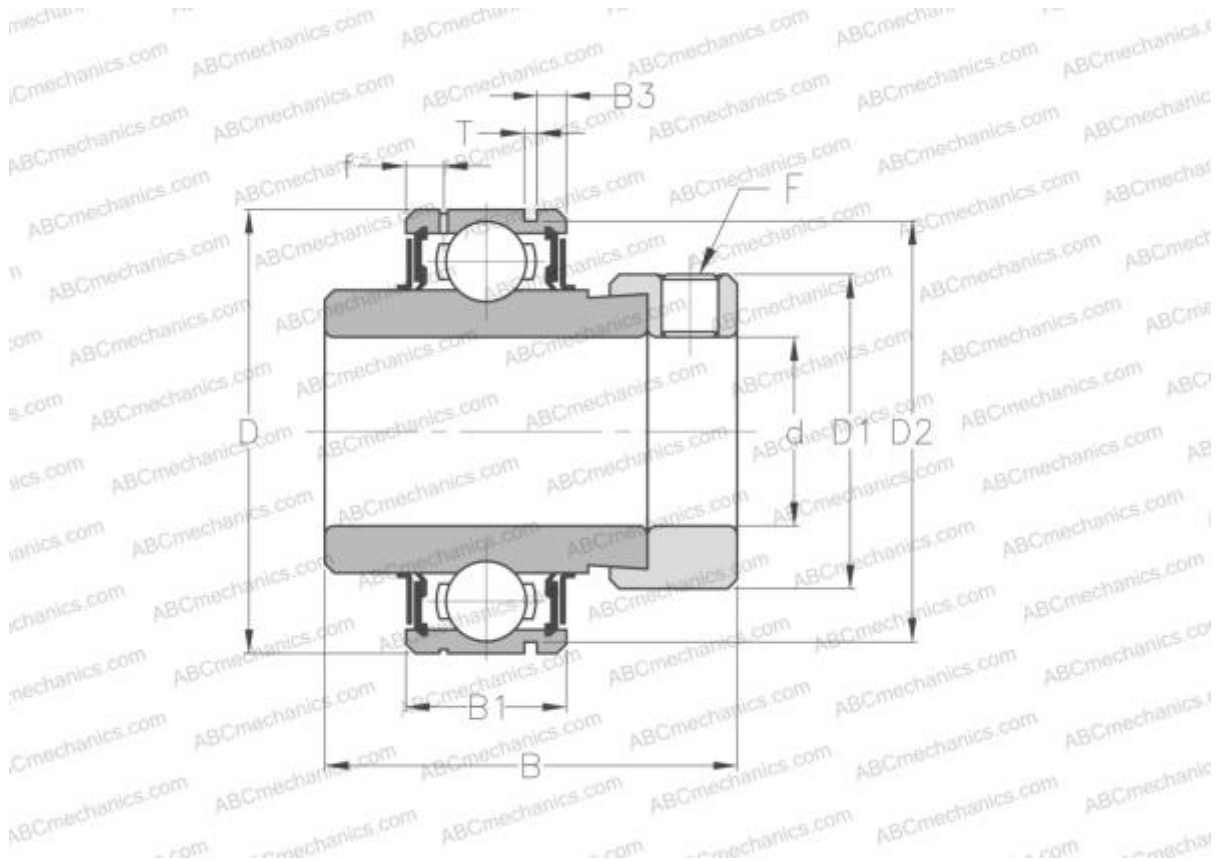

Technical specification

DIMENSIONS, MM

d	25,000
D	52,000
D1	38,100
B	44,400
B1	17,000
B2	34,900
c	17,500
F	M6x1

CALCULATION DATA

Operating temperature min	-20 °C
Operating temperature max	110 °C

MANUFACTURER

[SNR](#)

INTERCHANGE

ABC	CEX205
-----	------------------------

CALCULATION DATA

Basic dynamic load rating, C	14,000 kN
Basic static load rating, Co	7,880 kN