

CEX206 ABC

Insert bearings

TYPE: Ball bearings, Radial insert bearings, With eccentric locking collar, Cylindrical outer ring, snap ring, Seals on both side, relubrication

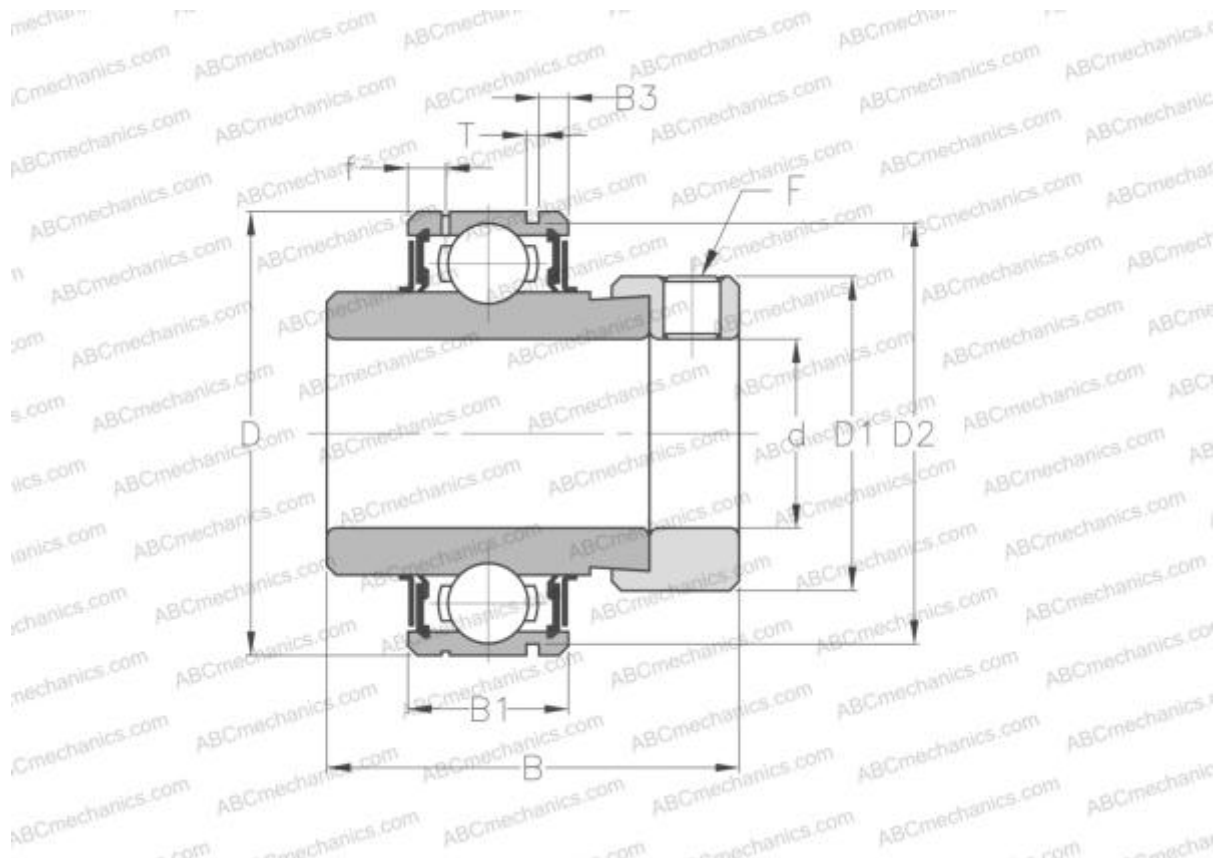

Technical specification

DIMENSIONS, MM

d	30,000
D	62,000
D1	44,500
B	48,400
B1	19,000
B2	36,500
c	18,300
F	M6x1

MANUFACTURER [ABC](#)

INTERCHANGE

SNR [CEX206](#)