

## CEX207 SNR

Insert bearings

TYPE: Ball bearings, Radial insert bearings, With eccentric locking collar, Cylindrical outer ring, snap ring, Seals on both side, relubrication

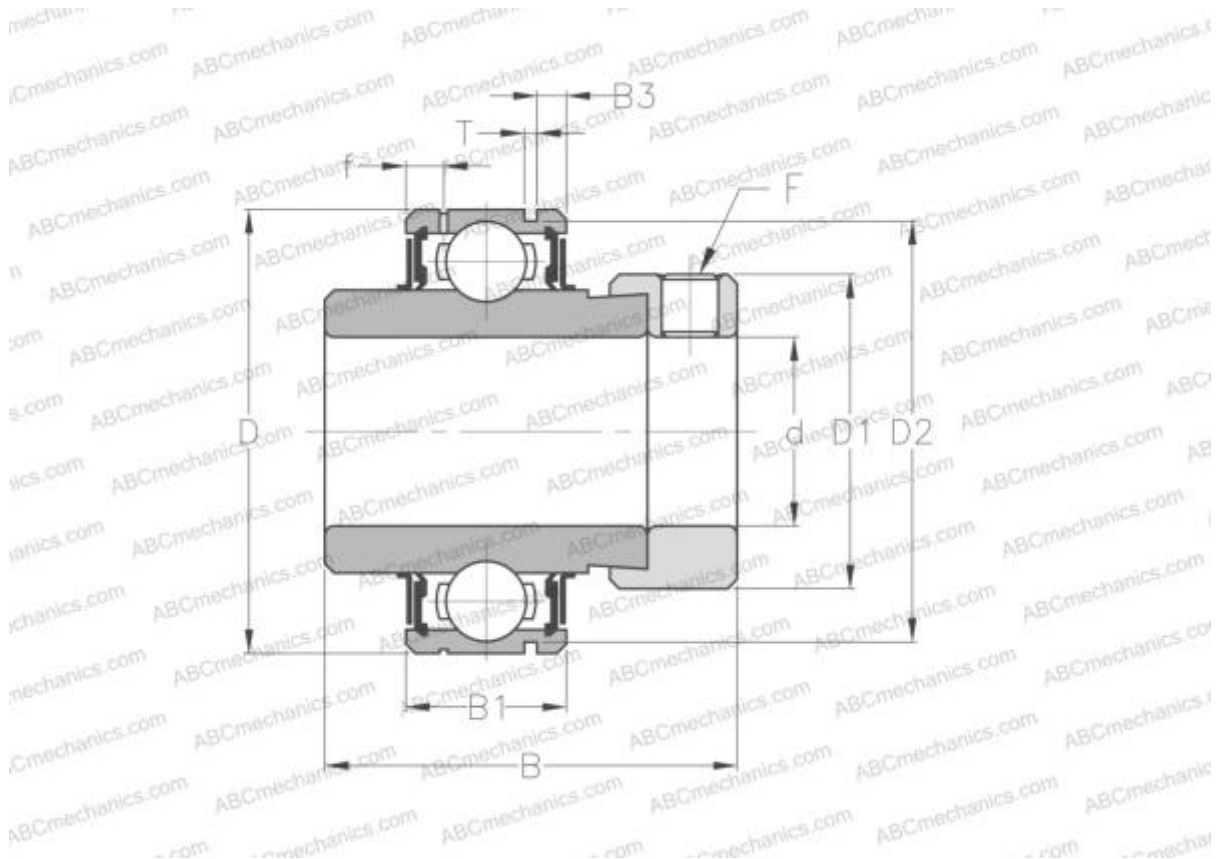

### Technical specification

#### DIMENSIONS, MM

d	35,000
D	72,000
D1	55,500
B	51,100
B1	20,000
B2	37,600
c	18,800
F	M8x1

#### CALCULATION DATA

Operating temperature min	-20 °C
Operating temperature max	110 °C

#### MANUFACTURER

[SNR](#)

#### INTERCHANGE

ABC	<a href="#">CEX207</a>
-----	------------------------

#### CALCULATION DATA

Basic dynamic load rating, C	25,700 kN
Basic static load rating, Co	15,200 kN