

CEX208 ABC

Insert bearings

TYPE: Ball bearings, Radial insert bearings, With eccentric locking collar, Cylindrical outer ring, snap ring, Seals on both side, relubrication

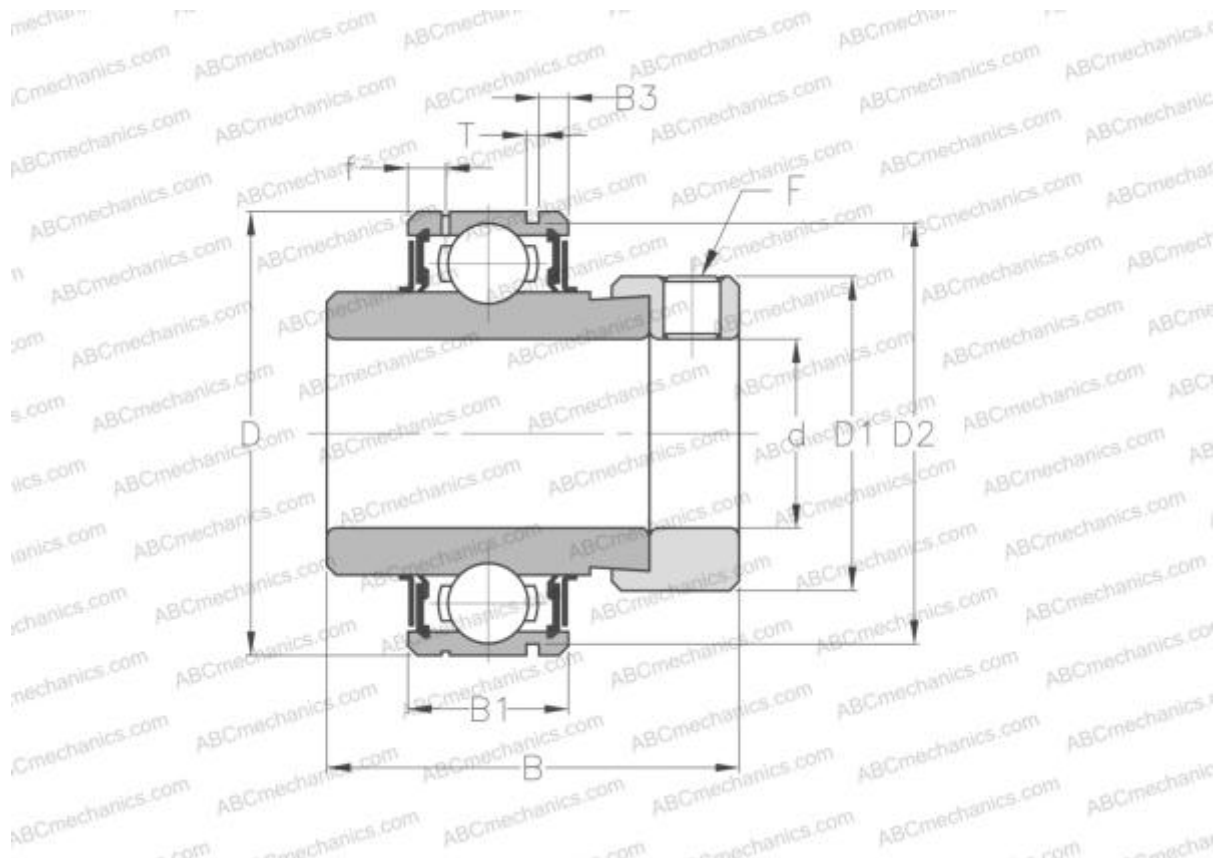

Technical specification

DIMENSIONS, MM

d	40,000
D	80,000
D1	60,300
B	56,300
B1	21,000
B2	42,800
c	21,400
F	M8x1

MANUFACTURER [ABC](#)

INTERCHANGE

SNR [CEX208](#)