

CEX205-14 ABC

Insert bearings

TYPE: Ball bearings, Radial insert bearings, With eccentric locking collar, Cylindrical outer ring, snap ring, Seals on both side, relubrication, inch size

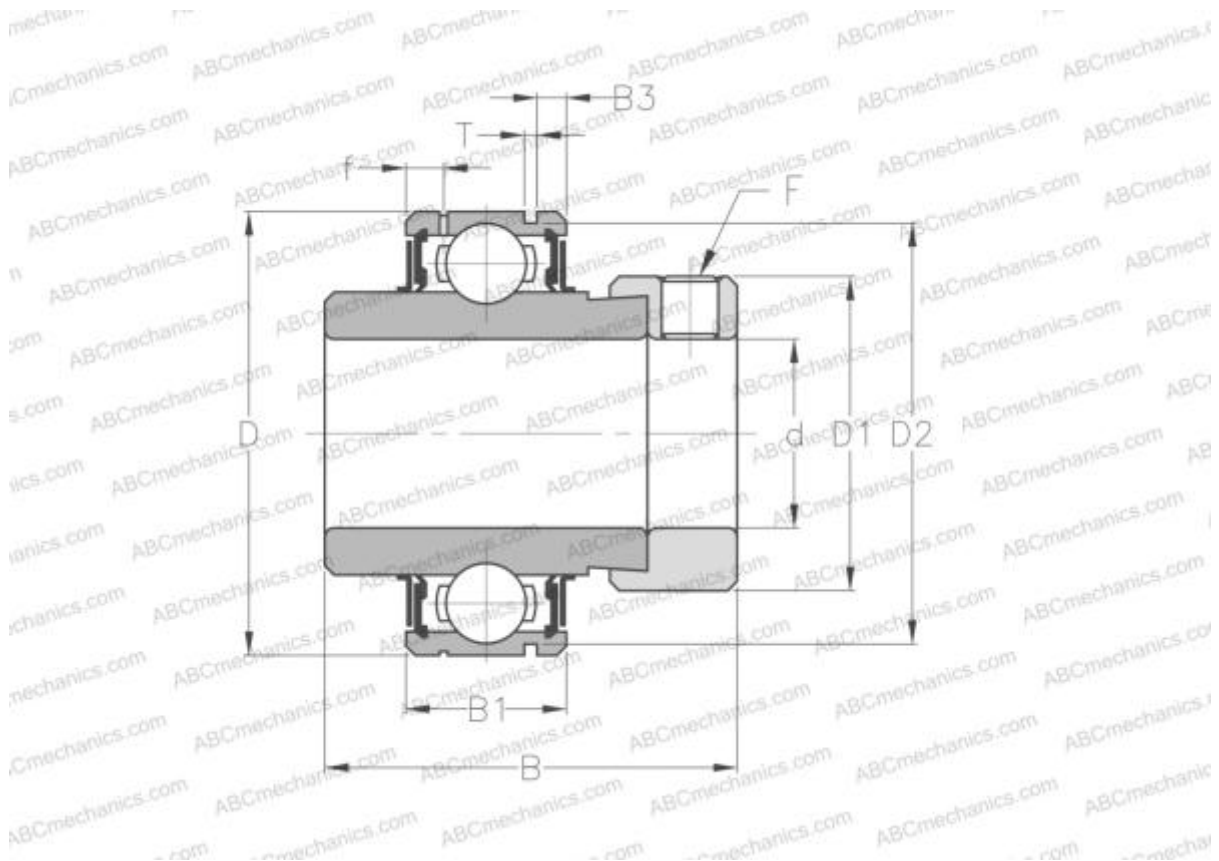

Technical specification

DIMENSIONS, MM

d	22,225
D	52,000
D1	38,100
B	44,400
B1	17,000
B2	34,900
c	17,500
F	1/4-28UNF

MANUFACTURER [ABC](#)

INTERCHANGE

SNR [CEX205-14](#)