

AY17-NPP-B INA

Insert bearings

TYPE: Ball bearings, Radial insert bearings, Grub screw to inner ring, Spherical outer ring, Seals on both side, P seal, without re-lubrication

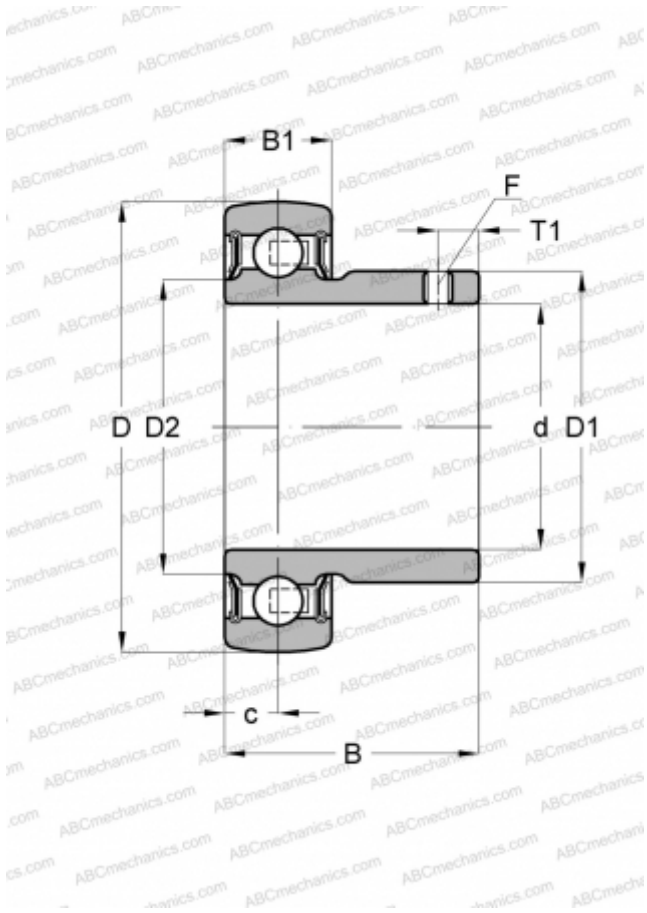

Technical specification

DIMENSIONS, MM

d	17,000
D	40,000
D1	23,900
D2	22,900
B	22,000
B1	12,000
c	6,000
T1	4,000
F	2.5

MANUFACTURER

[INA](#)

CALCULATION DATA

Basic dynamic load rating, C	9,800 kN
Basic static load rating, Co	4,750 kN
Operating temperature min	-20 °C
Operating temperature max	120 °C

REPLACES

AY17-XL-NPP-B