

UC201G2 SNR

Insert bearings

TYPE: Ball bearings, Radial insert bearings, Grub screw to inner ring, Spherical outer ring, Seals on both side, R seal, relubrication

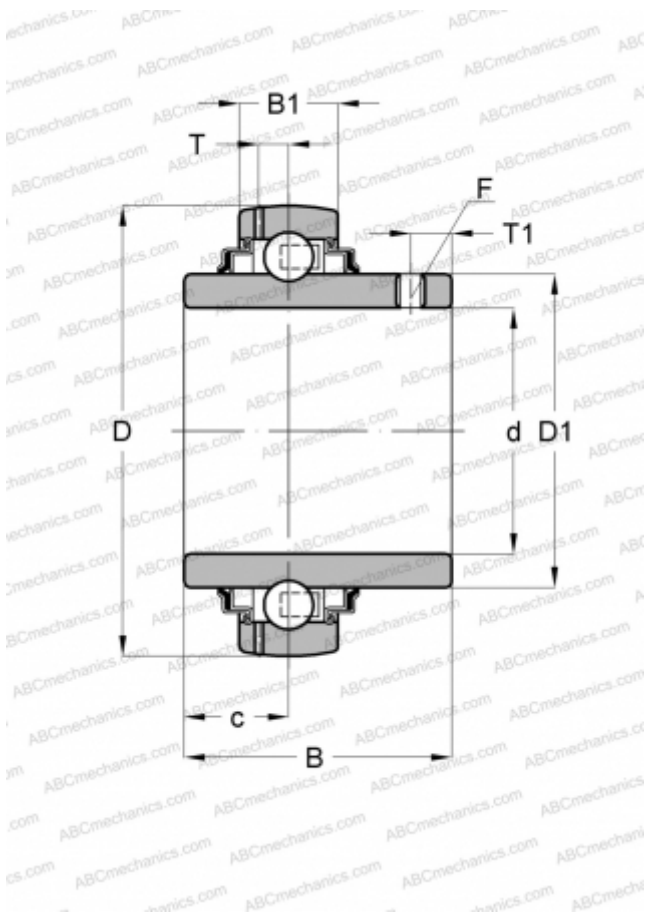

Technical specification

DIMENSIONS, MM

d	12,000
D	47,000
D1	29,000
B	31,000
B1	16,000
c	12,700
T	4,400
T1	4,700
F	M6x1

MANUFACTURER

[SNR](#)

INTERCHANGE

ABC	UC 201
ASAHI	UC 201
SLB	UC 201
FYH	UC 201
NTN	UC 201 D1

CALCULATION DATA

Basic dynamic load rating, C	12,800 kN
Basic static load rating, Co	6,650 kN
Operating temperature min	-20 °C
Operating temperature max	110 °C