

SER 202 ASAHI

Insert bearings

TYPE: Ball bearings, Radial insert bearings, Grub screw to inner ring, Cylindrical outer ring, snap ring, Seals on both side, relubrication

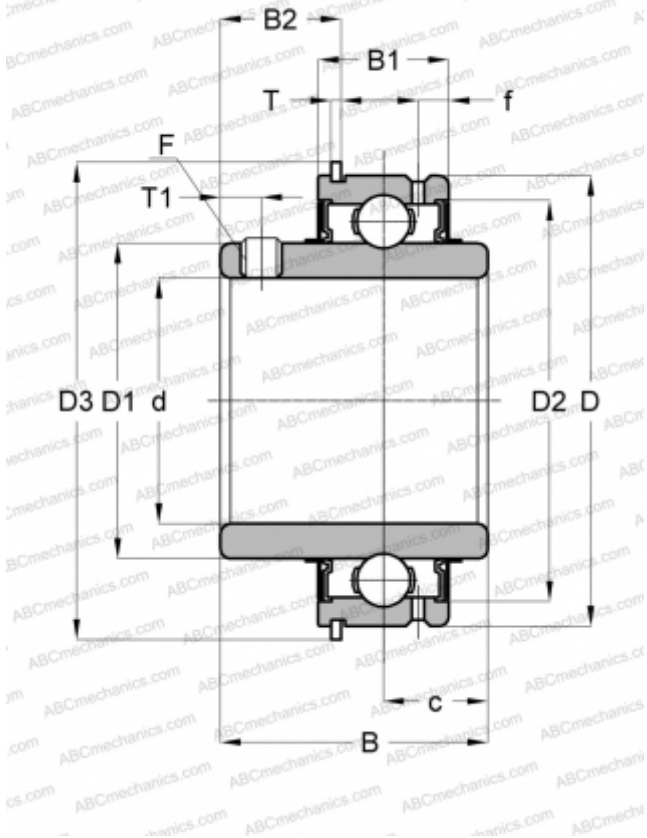

Technical specification

DIMENSIONS, MM

d	15,000
D	47,000
D1	29,000
D2	41,000
D3	52,700
B	31,000
B1	15,900
B2	16,150
f	3,800
c	10,300
T	1,070
T1	4,500
F	M6 x 0.75

MANUFACTURER

[ASAHI](#)

INTERCHANGE

ABC

[SER 202](#)