

SER 205 ASAHI

Insert bearings

TYPE: Ball bearings, Radial insert bearings, Grub screw to inner ring, Cylindrical outer ring, snap ring, Seals on both side, relubrication

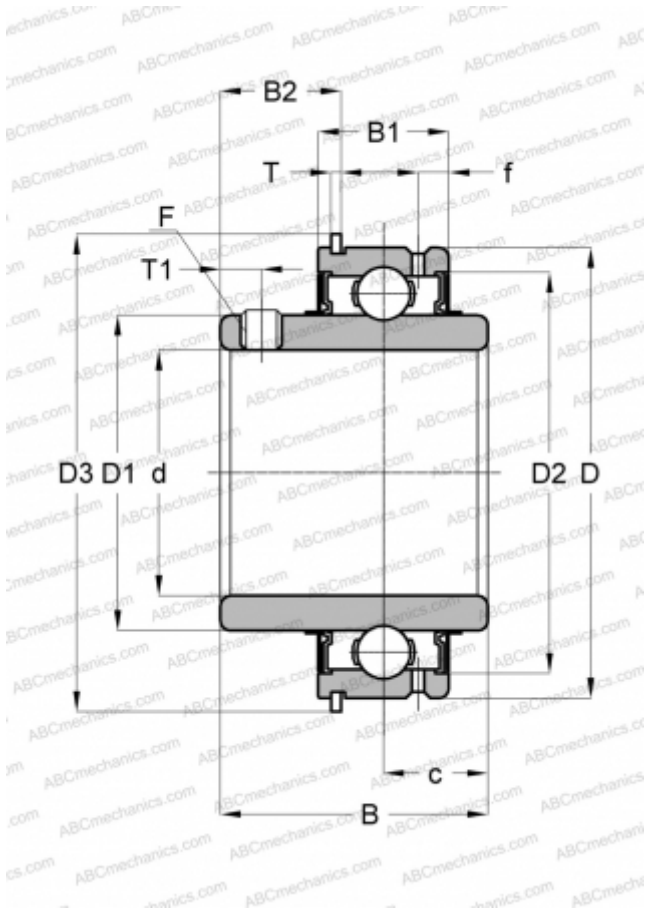

Technical specification

DIMENSIONS, MM

d	25,000
D	52,000
D1	34,000
D2	46,000
D3	57,900
B	34,900
B1	19,000
B2	15,750
f	5,200
c	13,100
T	1,070
T1	5,000
F	M6 x 0.75

MANUFACTURER

[ASAHI](#)

INTERCHANGE

ABC	SER 205
SNR	CUC205