

SER 203-11 ASAHI

Insert bearings

TYPE: Ball bearings, Radial insert bearings, Grub screw to inner ring, Cylindrical outer ring, snap ring, Seals on both side, relubrication, inch size

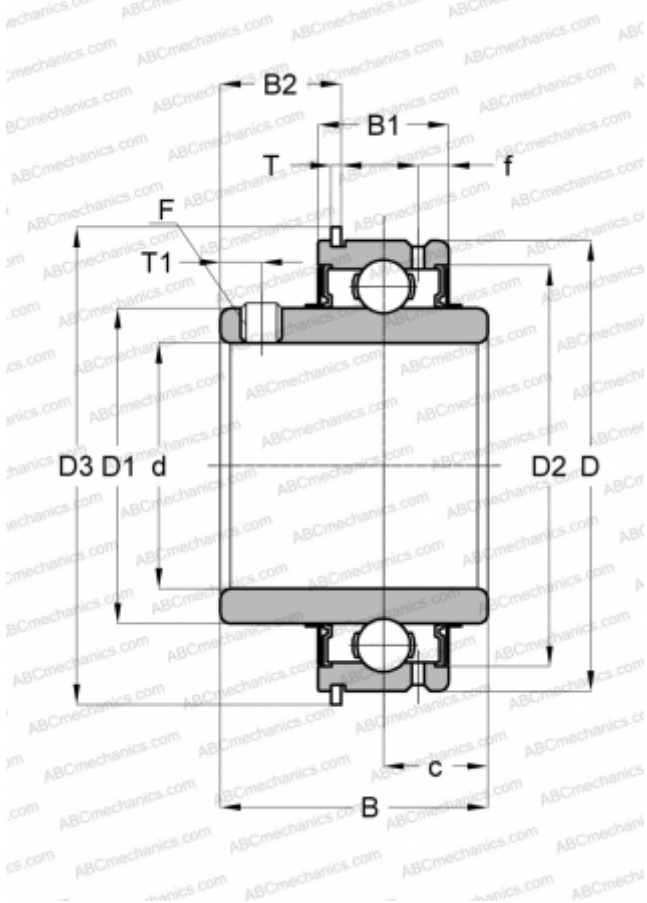

Technical specification

DIMENSIONS, MM

d	17,462
D	47,000
D1	29,007
D2	40,996
D3	52,705
B	30,958
B1	15,875
B2	16,154
f	3,810
c	10,320
T	1,067
T1	4,496
F	1/4-28

MANUFACTURER

[ASAHI](#)

INTERCHANGE

ABC [SER 203-11](#)