

## CUS207 SNR

Insert bearings

TYPE: Ball bearings, Radial insert bearings, Grub screw to inner ring, Cylindrical outer ring, snap ring, Seals on both side, with inner ring extended at one side

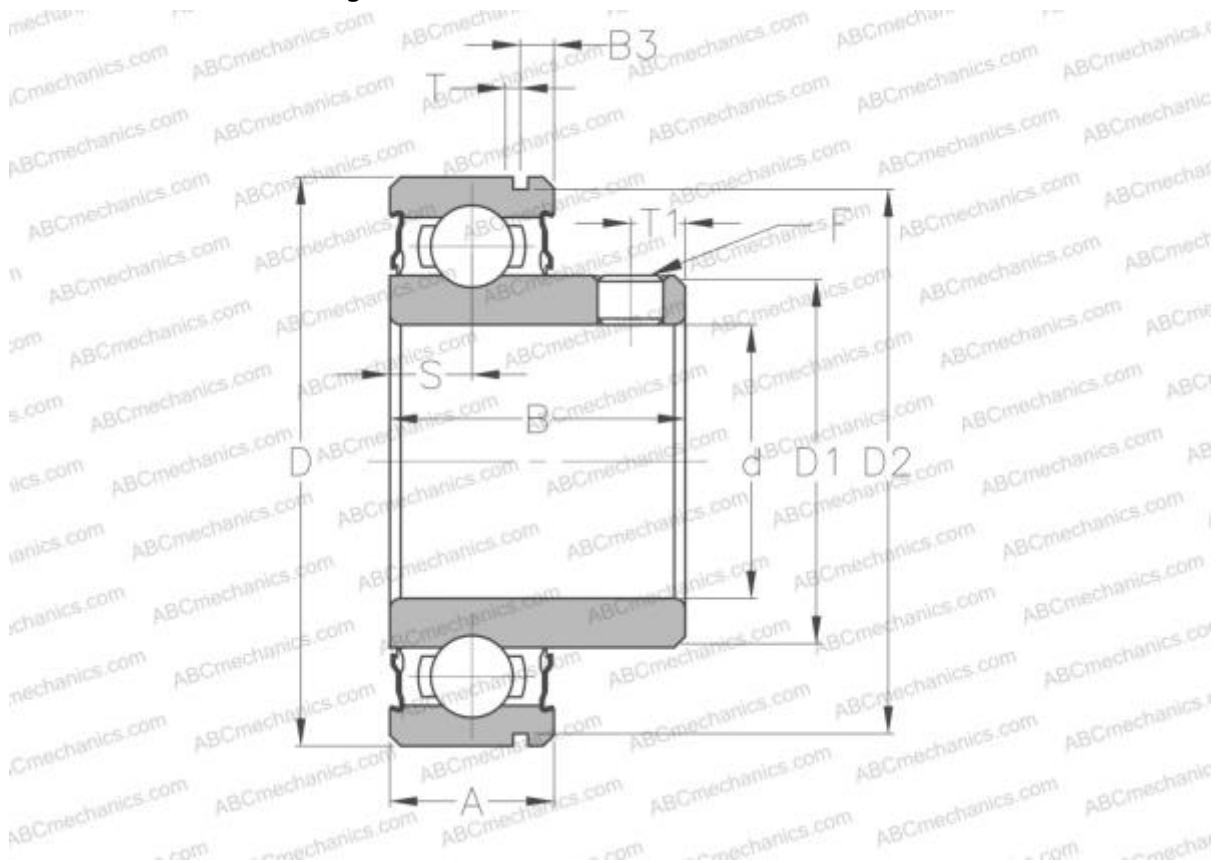

### Technical specification

#### DIMENSIONS, MM

d	35,000
D	72,000
D1	46,900
B	32,000
B1	17,000
c	8,500
T1	6,000
F	M6 x 1

#### MANUFACTURER

[SNR](#)

#### CALCULATION DATA

Basic dynamic load rating, C	25,700 kN
Basic static load rating, Co	15,200 kN
Operating temperature min	-20 °C
Operating temperature max	110 °C