

## CUS208 SNR

Insert bearings

TYPE: Ball bearings, Radial insert bearings, Grub screw to inner ring, Cylindrical outer ring, snap ring, Seals on both side, with inner ring extended at one side

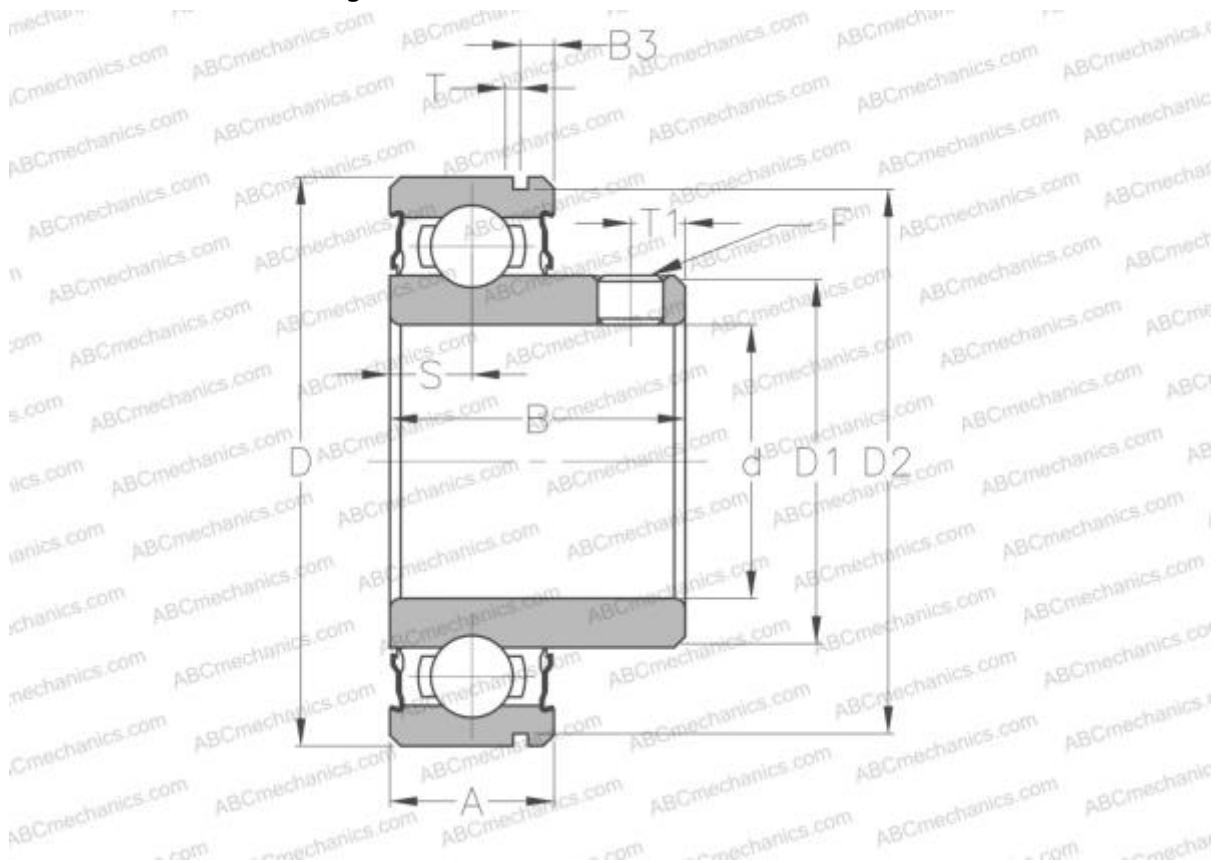

### Technical specification

#### DIMENSIONS, MM

d	40,000
D	80,000
D1	52,400
B	34,000
B1	18,000
c	9,000
T1	8,000
F	M8 x 1

#### MANUFACTURER

[SNR](#)

#### CALCULATION DATA

Basic dynamic load rating, C	29,600 kN
Basic static load rating, Co	18,200 kN
Operating temperature min	-20 °C
Operating temperature max	110 °C