

## CUS206-19 SNR

Insert bearings

TYPE: Ball bearings, Radial insert bearings, Grub screw to inner ring, Seals on both side, with inner ring extended at one side, inch size, Cylindrical outer ring, snap ring

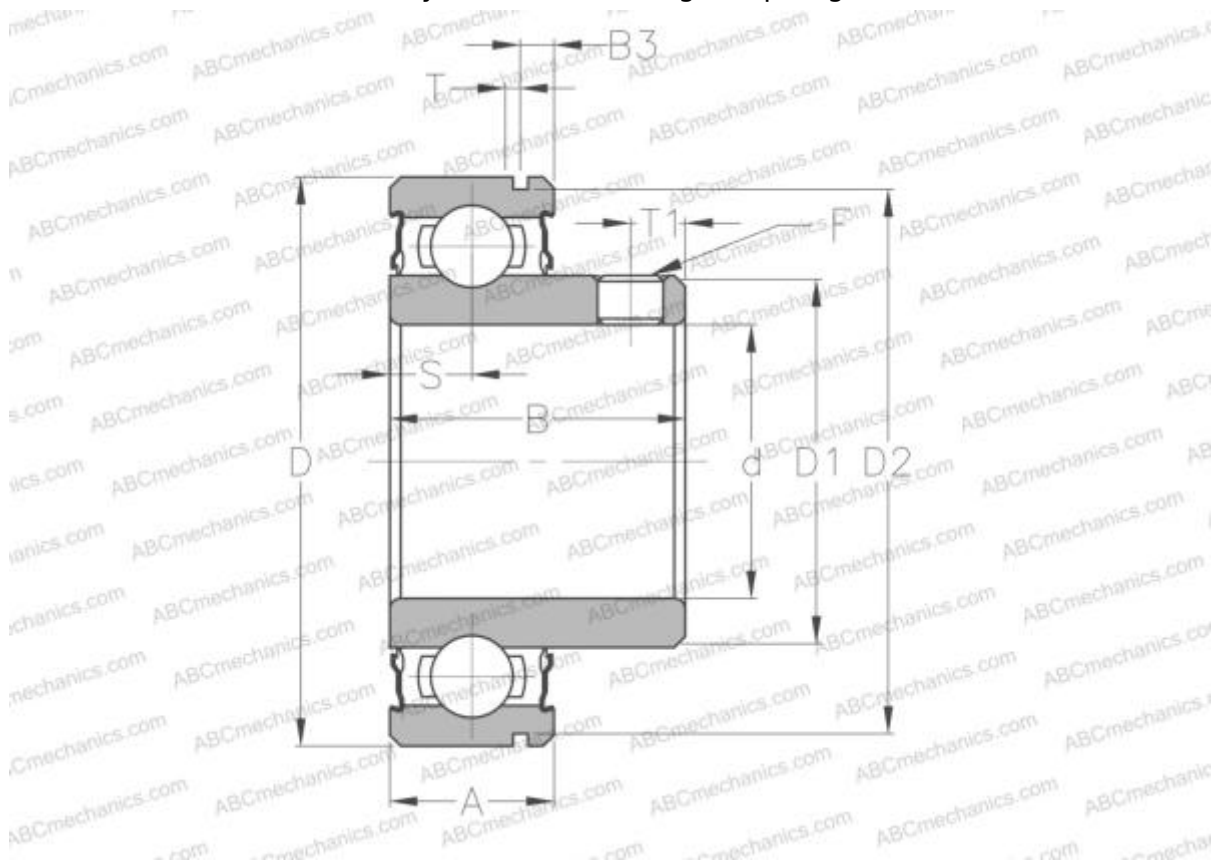

### Technical specification

#### DIMENSIONS, MM

d	30,163
D	62,000
D1	40,000
B	30,000
B1	16,000
c	8,000
T1	5,500
F	1/4-28UNF

#### MANUFACTURER

[SNR](#)

#### CALCULATION DATA

Basic dynamic load rating, C	19,500 kN
Basic static load rating, Co	11,200 kN
Operating temperature min	-20 °C
Operating temperature max	110 °C