

CUS207-23 SNR

Insert bearings

TYPE: Ball bearings, Radial insert bearings, Grub screw to inner ring, Seals on both side, with inner ring extended at one side, inch size, Cylindrical outer ring, snap ring

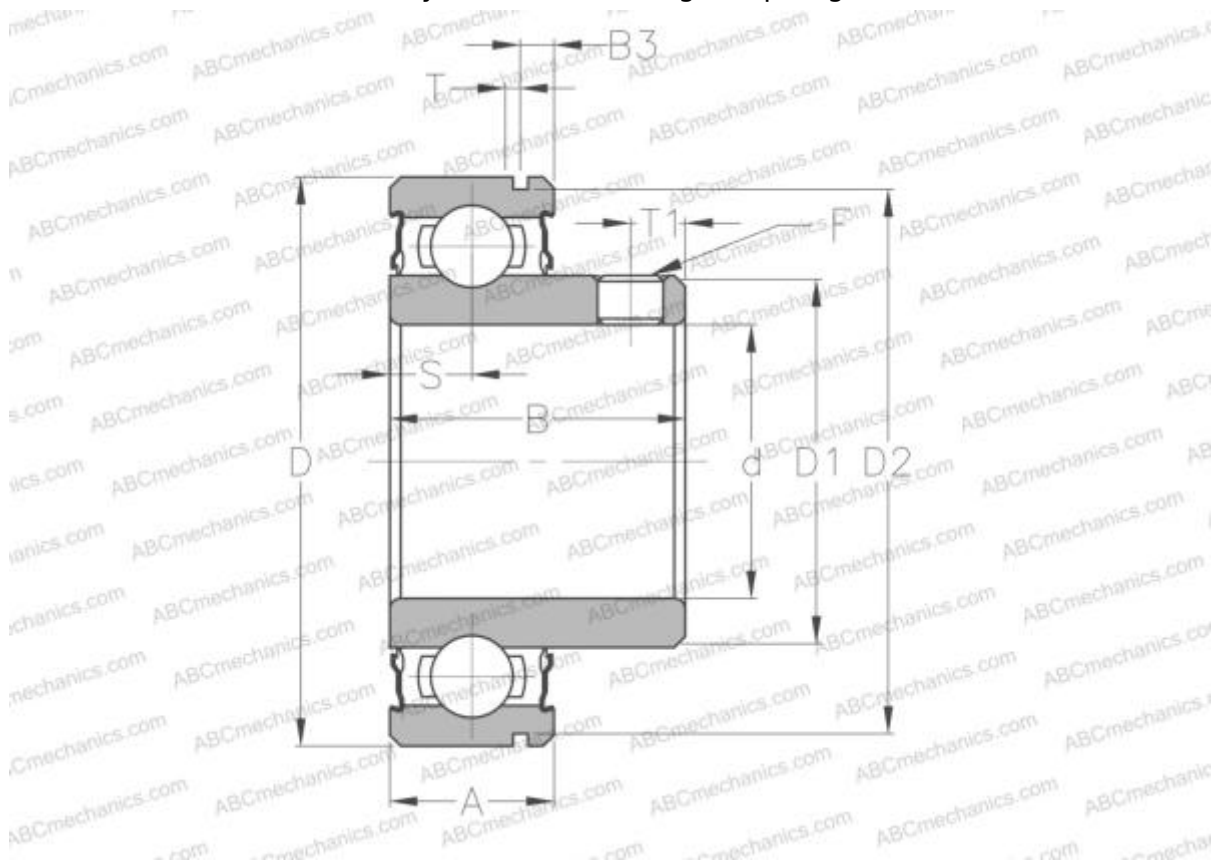

Technical specification

DIMENSIONS, MM

d	36,513
D	72,000
D1	46,900
B	32,000
B1	17,000
c	8,500
T1	6,000
F	1/4-28UNF

MANUFACTURER

[SNR](#)

CALCULATION DATA

Basic dynamic load rating, C	25,700 kN
Basic static load rating, Co	15,200 kN
Operating temperature min	-20 °C
Operating temperature max	110 °C