

SES201 SNR

Insert bearings

TYPE: Ball bearings, Radial insert bearings, With eccentric locking collar, Spherical outer ring, Series SES(SNR), seals on both side, corrosion resistant

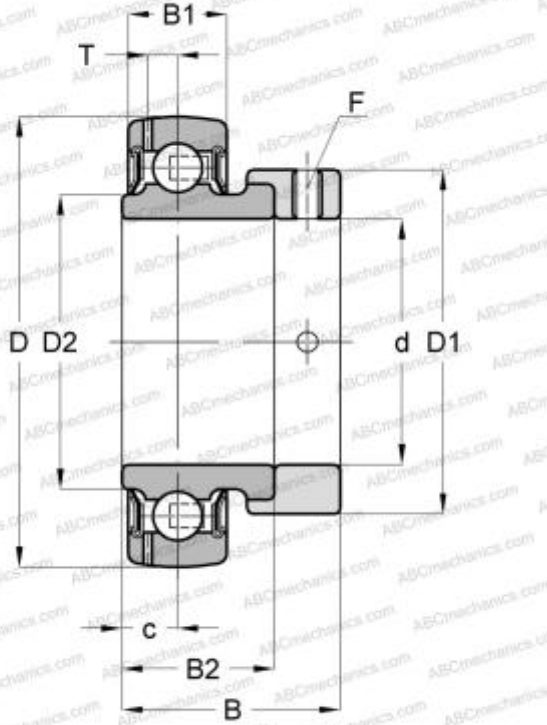

Technical specification

DIMENSIONS, MM

d	12,000
D	40,000
D1	28,600
B	28,600
B1	12,000
B2	19,100
c	6,000
F	M6x1

MANUFACTURER

[SNR](#)

CALCULATION DATA

Basic dynamic load rating, C	7,800 kN
Basic static load rating, Co	4,500 kN
Operating temperature min	-20 °C
Operating temperature max	120 °C