

## SES209 SNR

Insert bearings

TYPE: Ball bearings, Radial insert bearings, With eccentric locking collar, Spherical outer ring, Series SES(SNR), seals on both side, corrosion resistant

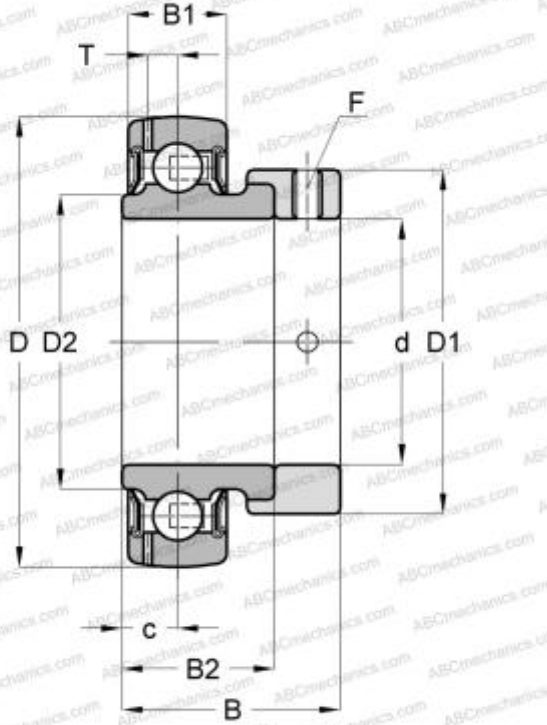

### Technical specification

#### DIMENSIONS, MM

d	45,000
D	85,000
D1	63,500
B	43,700
B1	19,000
B2	30,200
c	9,500
F	M8x1

#### MANUFACTURER

[SNR](#)

#### CALCULATION DATA

Basic dynamic load rating, C	25,700 kN
Basic static load rating, Co	20,800 kN
Operating temperature min	-20 °C
Operating temperature max	120 °C