

SES204-12 SNR

Insert bearings

TYPE: Ball bearings, Radial insert bearings, With eccentric locking collar, Spherical outer ring, Series SES(SNR), seals on both side, corrosion resistant, inch size

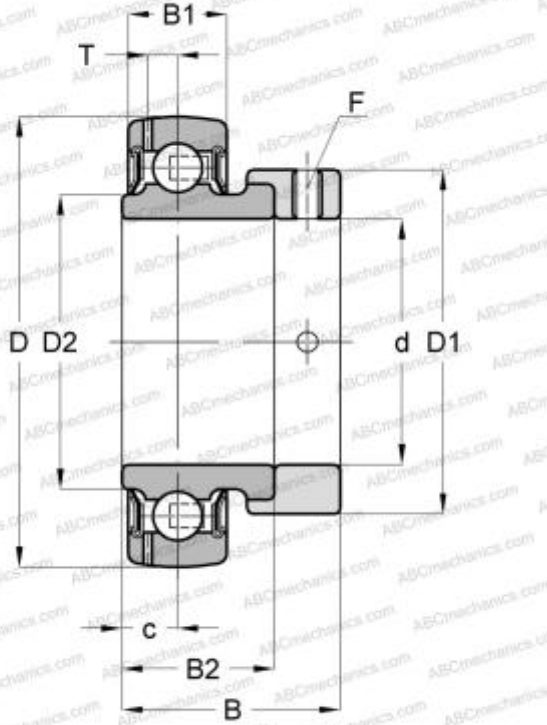

Technical specification

DIMENSIONS, MM

d	19,050
D	47,000
D1	33,300
B	31,000
B1	14,000
B2	21,500
c	7,000
F	M6x1

MANUFACTURER

[SNR](#)

CALCULATION DATA

Basic dynamic load rating, C	10,100 kN
Basic static load rating, Co	6,800 kN
Operating temperature min	-20 °C
Operating temperature max	120 °C