

SES206-20 SNR

Insert bearings

TYPE: Ball bearings, Radial insert bearings, With eccentric locking collar, Spherical outer ring, Series SES(SNR), seals on both side, corrosion resistant, inch size

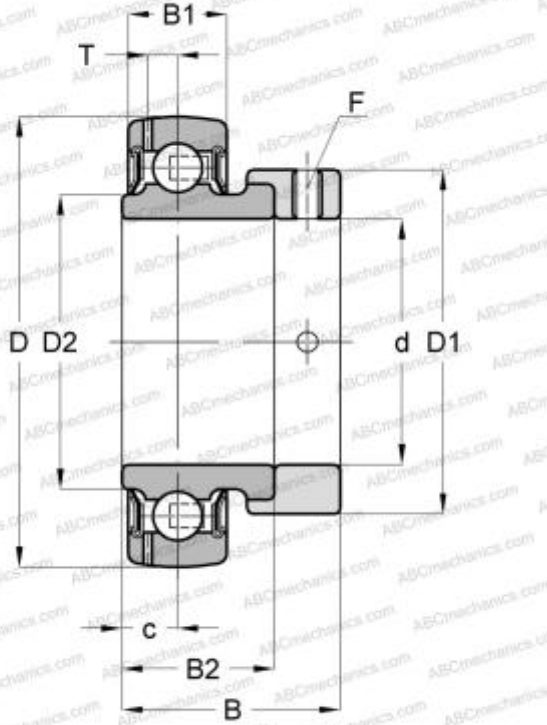

Technical specification

DIMENSIONS, MM

d	31,750
D	62,000
D1	44,500
B	35,700
B1	16,000
B2	23,800
c	8,000
F	M8x1

MANUFACTURER

[SNR](#)

CALCULATION DATA

Basic dynamic load rating, C	15,300 kN
Basic static load rating, Co	11,500 kN
Operating temperature min	-20 °C
Operating temperature max	120 °C