

SES207-23 SNR

Insert bearings

TYPE: Ball bearings, Radial insert bearings, With eccentric locking collar, Spherical outer ring, Series SES(SNR), seals on both side, corrosion resistant, inch size

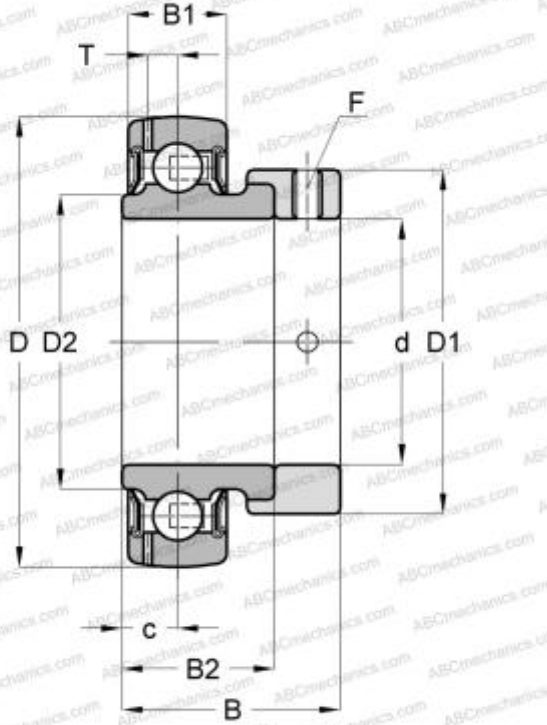

Technical specification

DIMENSIONS, MM

d	36,513
D	72,000
D1	55,600
B	38,900
B1	17,000
B2	25,400
c	8,500
F	M8x1

MANUFACTURER

[SNR](#)

CALCULATION DATA

Basic dynamic load rating, C	20,100 kN
Basic static load rating, Co	15,600 kN
Operating temperature min	-20 °C
Operating temperature max	120 °C