

SES208-24 SNR

Insert bearings

TYPE: Ball bearings, Radial insert bearings, With eccentric locking collar, Spherical outer ring, Series SES(SNR), seals on both side, corrosion resistant, inch size

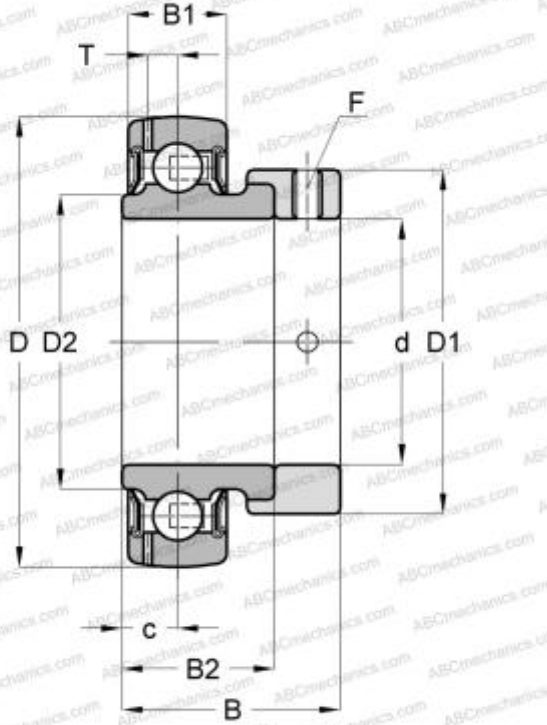

Technical specification

DIMENSIONS, MM

d	38,100
D	80,000
D1	60,300
B	43,700
B1	18,000
B2	30,200
c	9,000
F	M8x1

MANUFACTURER

[SNR](#)

CALCULATION DATA

Basic dynamic load rating, C	22,800 kN
Basic static load rating, Co	18,200 kN
Operating temperature min	-20 °C
Operating temperature max	120 °C