

## SUC204 SNR

Insert bearings

TYPE: Ball bearings, Radial insert bearings, Grub screw to inner ring, Spherical outer ring, Series SUC(SNR), seals on both side, corrosion resistant

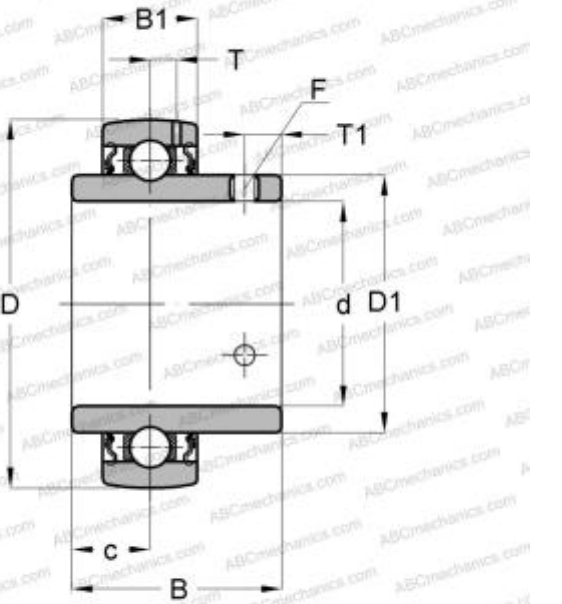

### Technical specification

#### DIMENSIONS, MM

d	20,000
D	47,000
B	31,000
B1	17,000
c	12,700
T1	5,000
F	M6x1

#### MANUFACTURER

[SNR](#)

#### CALCULATION DATA

Basic dynamic load rating, C	10,100 kN
Basic static load rating, Co	6,800 kN
Operating temperature min	-20 °C
Operating temperature max	120 °C