

SUC208 SNR

Insert bearings

TYPE: Ball bearings, Radial insert bearings, Grub screw to inner ring, Spherical outer ring, Series SUC(SNR), seals on both side, corrosion resistant

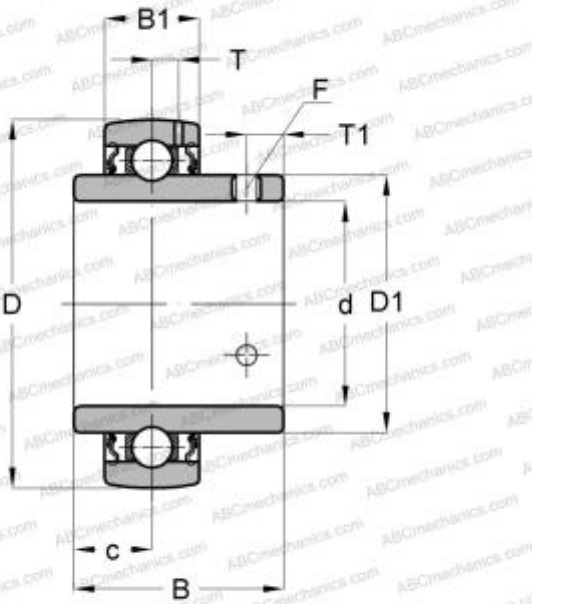

Technical specification

DIMENSIONS, MM

d	40,000
D	80,000
B	49,200
B1	21,000
c	19,000
T1	8,000
F	M8x1

MANUFACTURER

[SNR](#)

CALCULATION DATA

Basic dynamic load rating, C	22,800 kN
Basic static load rating, Co	18,200 kN
Operating temperature min	-20 °C
Operating temperature max	120 °C