

SUC205-16 SNR

Insert bearings

TYPE: Ball bearings, Radial insert bearings, Grub screw to inner ring, Spherical outer ring, Series SUC(SNR), seals on both side, corrosion resistant, inch size

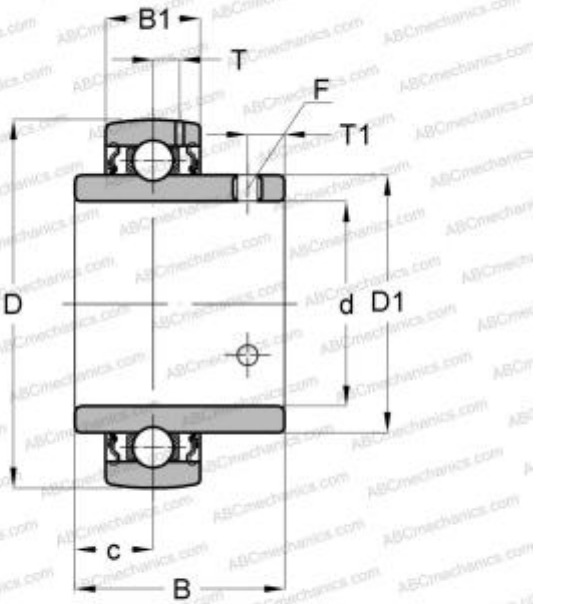

Technical specification

DIMENSIONS, MM

d	25,400
D	52,000
B	34,100
B1	17,000
c	14,300
T1	5,000
F	M6x1

MANUFACTURER

[SNR](#)

CALCULATION DATA

Basic dynamic load rating, C	11,000 kN
Basic static load rating, Co	8,000 kN
Operating temperature min	-20 °C
Operating temperature max	120 °C