

SUC206-20 SNR

Insert bearings

TYPE: Ball bearings, Radial insert bearings, Grub screw to inner ring, Spherical outer ring, Series SUC(SNR), seals on both side, corrosion resistant, inch size

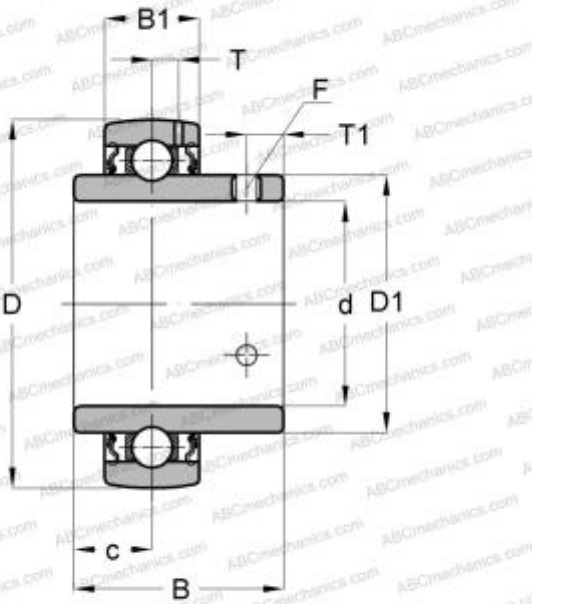

Technical specification

DIMENSIONS, MM

d	31,750
D	62,000
B	38,100
B1	19,000
c	15,900
T1	5,000
F	M6x1

MANUFACTURER

[SNR](#)

CALCULATION DATA

Basic dynamic load rating, C	15,300 kN
Basic static load rating, Co	11,500 kN
Operating temperature min	-20 °C
Operating temperature max	120 °C