

SUC207-23 SNR

Insert bearings

TYPE: Ball bearings, Radial insert bearings, Grub screw to inner ring, Spherical outer ring, Series SUC(SNR), seals on both side, corrosion resistant, inch size

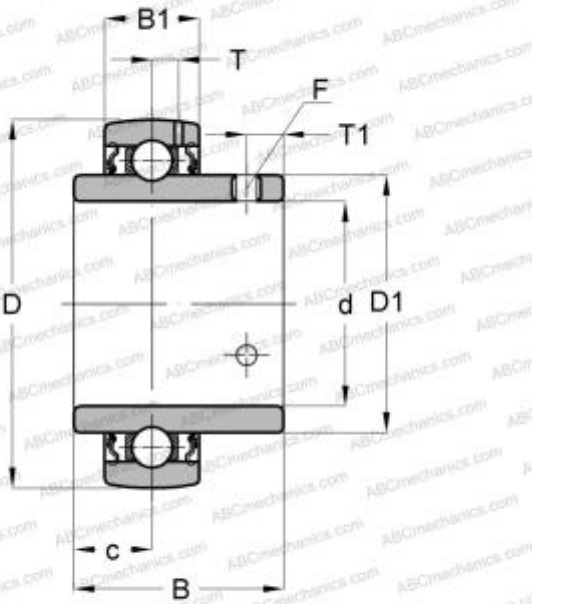

Technical specification

DIMENSIONS, MM

d	36,513
D	72,000
B	42,900
B1	20,000
c	17,500
T1	6,000
F	M8x1

MANUFACTURER

[SNR](#)

CALCULATION DATA

Basic dynamic load rating, C	20,100 kN
Basic static load rating, Co	15,600 kN
Operating temperature min	-20 °C
Operating temperature max	120 °C