

SUC209-28 SNR

Insert bearings

TYPE: Ball bearings, Radial insert bearings, Grub screw to inner ring, Spherical outer ring, Series SUC(SNR), seals on both side, corrosion resistant, inch size

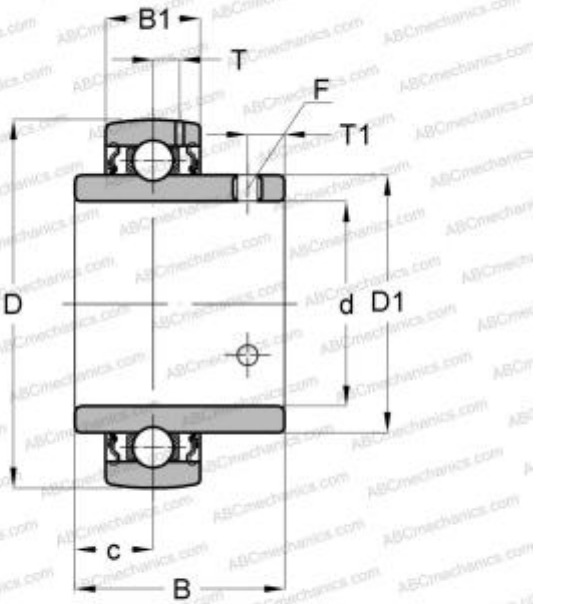

Technical specification

DIMENSIONS, MM

d	44,450
D	85,000
B	49,200
B1	22,000
c	19,000
T1	8,000
F	M10x1.25

MANUFACTURER

[SNR](#)

CALCULATION DATA

Basic dynamic load rating, C	25,700 kN
Basic static load rating, Co	20,800 kN
Operating temperature min	-20 °C
Operating temperature max	120 °C