

UC X05-15 SLB

Insert bearings

TYPE: Ball bearings, Radial insert bearings, Grub screw to inner ring, Spherical outer ring, Seals on both side, R seal, relubrication, medium duty, inch size

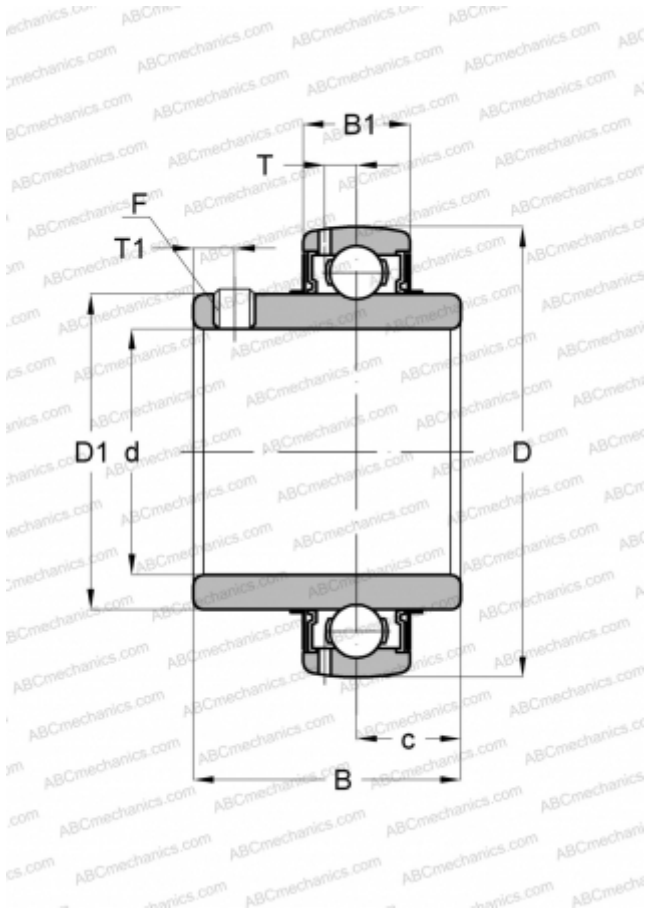

Technical specification

DIMENSIONS, MM

d	23,812
D	61,999
D1	40,488
B	38,100
B1	18,999
c	15,900
T	5,105
T1	5,004
F	1/4-28

MANUFACTURER

[SLB](#)

INTERCHANGE

ABC	UC X05-15
ASAHI	UC X05-15
NTN	UC X05-015 D1