

UC 201 FYH

Insert bearings

TYPE: Ball bearings, Radial insert bearings, Grub screw to inner ring, Spherical outer ring, Seals on both side, R seal, relubrication

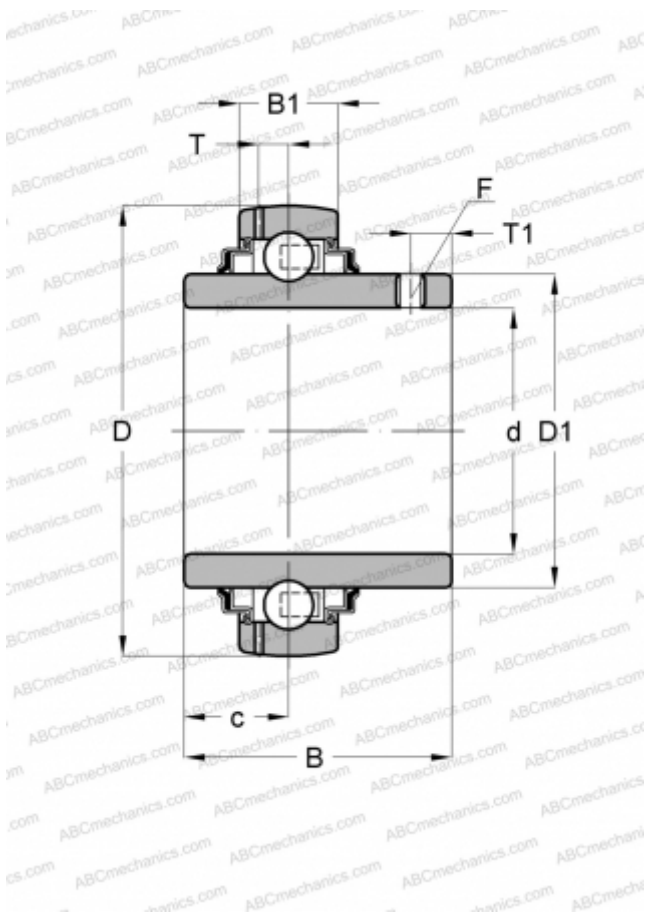

Technical specification

DIMENSIONS, MM

d	12,000
D	47,000
D1	29,000
B	31,000
B1	17,000
c	12,700
T	4,500
T1	4,500

MANUFACTURER

[FYH](#)

INTERCHANGE

ABC	UC 201
ASAHI	UC 201
SNR	UC201G2
SLB	UC 201
NTN	UC 201 D1