

UC 308 D1 NTN

Insert bearings

TYPE: Ball bearings, Radial insert bearings, Grub screw to inner ring, Spherical outer ring, Seals on both side, R seal, relubrication

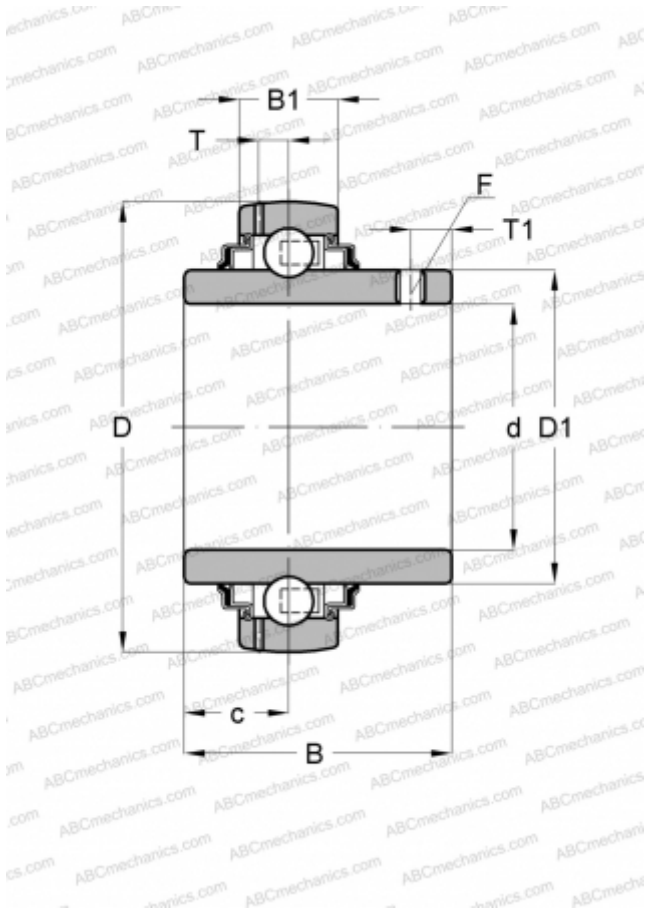

Technical specification

DIMENSIONS, MM

d	40,000
D	90,000
D1	56,000
B	52,000
B1	27,000
c	19,000
T	8,200
T1	10,000

MANUFACTURER

[NTN](#)

INTERCHANGE

ABC	UC 308
ASAHI	UC 308
SNR	UC308G2
SLB	UC 308
FYH	UC308