

NA202 FYH

Insert bearings

TYPE: Ball bearings, Radial insert bearings, With eccentric locking collar, Spherical outer ring, Seals on both side, R seal, relubrication

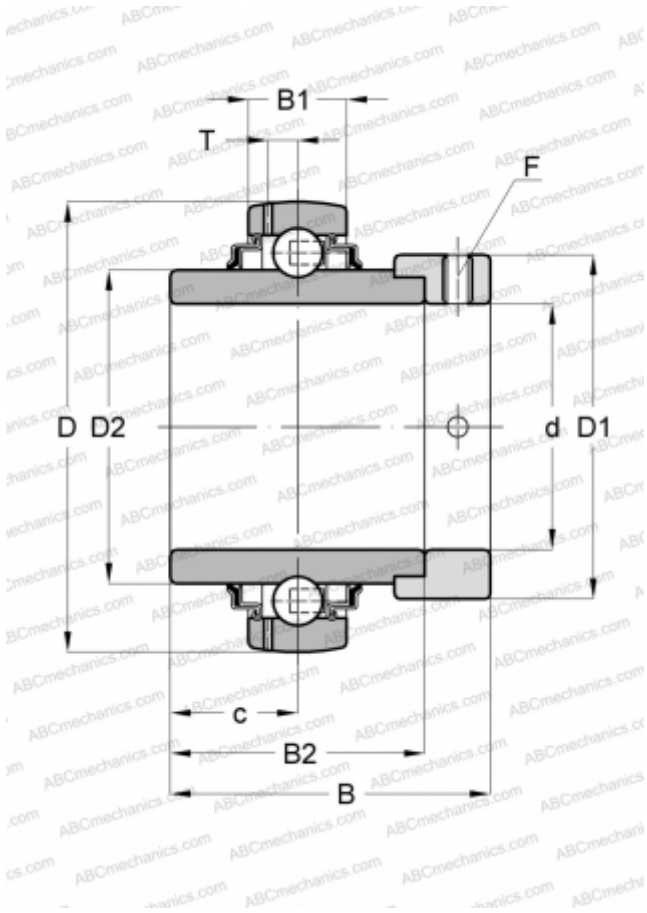

Technical specification

DIMENSIONS, MM

d	15,000
D	40,000
B	37,300
B1	15,000
B2	27,800

MANUFACTURER

[FYH](#)

INTERCHANGE

ABC	UGW 202+ER
ASAHI	UGW 202+ER
SLB	UEL202