

UEL 208 D1 W3 NTN

Insert bearings

TYPE: Ball bearings, Radial insert bearings, With eccentric locking collar, Spherical outer ring, Seals on both side, R seal, relubrication

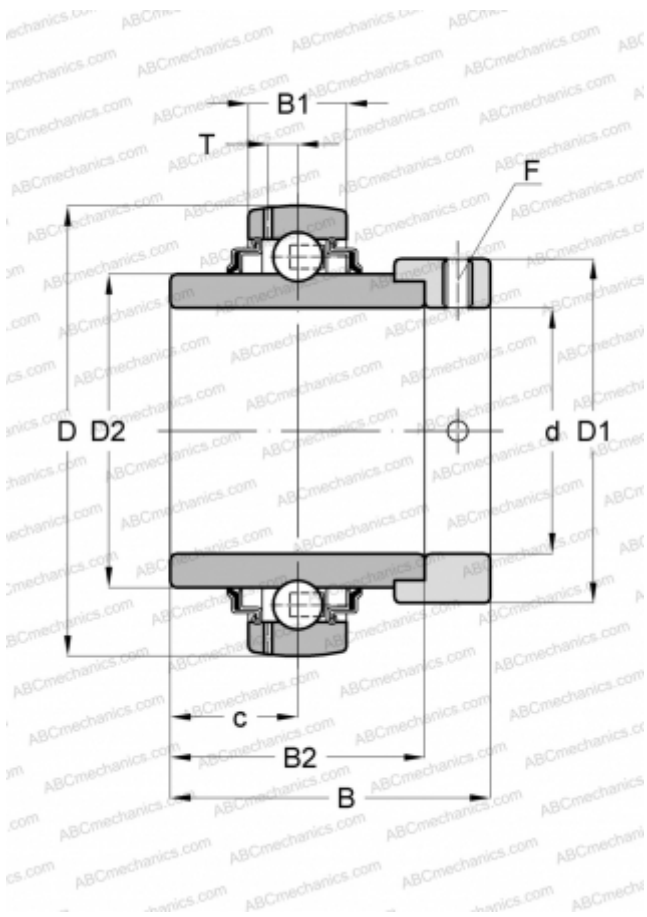

Technical specification

DIMENSIONS, MM

d	40,000
D	80,000
B	56,500
B1	21,000
B2	42,900

MANUFACTURER

[NTN](#)

INTERCHANGE

ABC	GE40-KRR-B
ASAHI	UG 208+ER
SKF	YEL 208-2F
INA	GE40-KRR-B
SNR	EX208G2
SLB	UEL208
FYH	NA208