

## UK 208 FYH

Insert bearings

TYPE: Ball bearings, Radial insert bearings, With adapter sleeve, Spherical outer ring, Seals on both side, RSR seal, relubrication

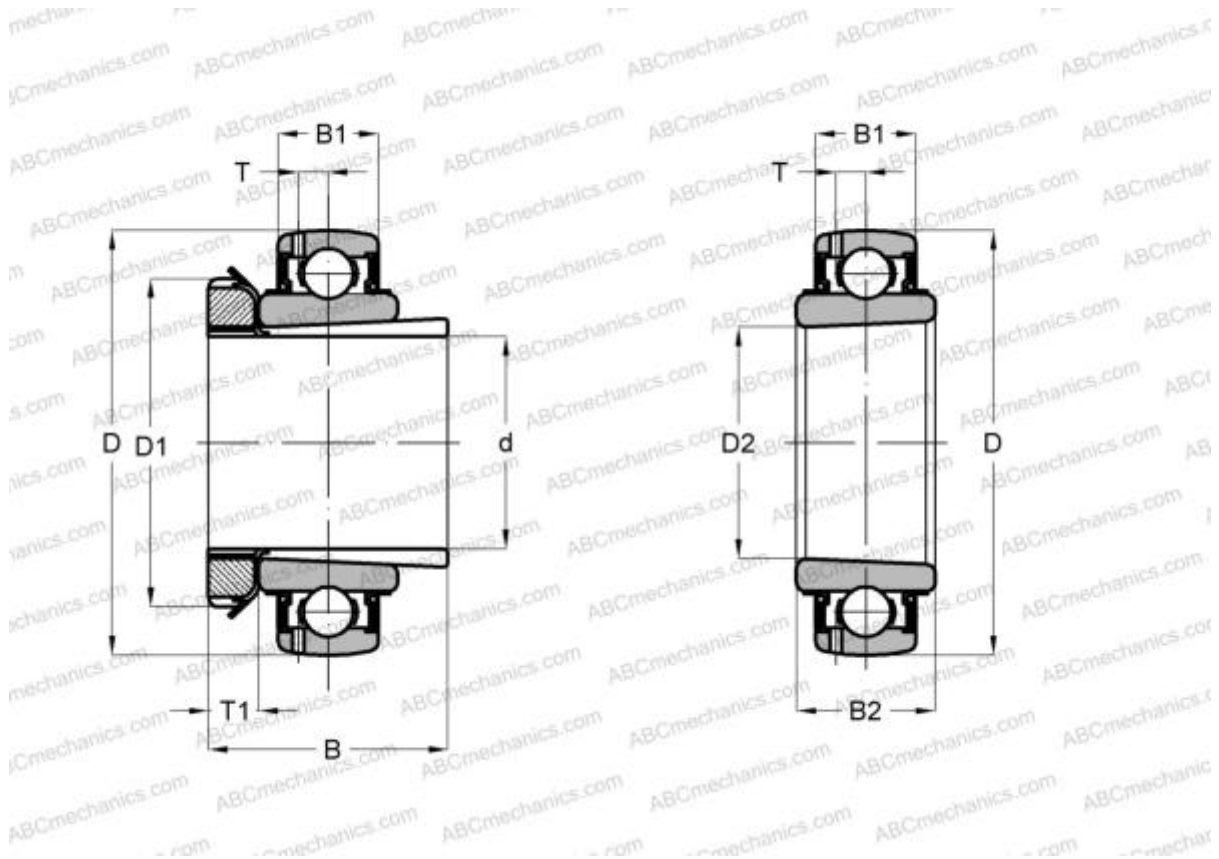

### Technical specification

#### DIMENSIONS, MM

d	35,000
D	80,000
D1	58,000
D2	40,000
B	46,000
B1	21,000
B2	29,000
T	6,200
T1	10,000

**MANUFACTURER** [FYH](#)

#### INTERCHANGE

ABC	<a href="#">UK 208 + H2308</a>
SKF	<a href="#">YSA 208-2FK</a>
ASAHI	<a href="#">UK 208 + H2308</a>

#### INTERCHANGE

FKL	<a href="#">LK 208 2F</a>
SNR	<a href="#">UK208+H</a>
SLB	<a href="#">UK208</a>
NTN	<a href="#">UK 208 D1</a>