

UK 208 D1 NTN

Insert bearings

TYPE: Ball bearings, Radial insert bearings, With adapter sleeve, Spherical outer ring, Seals on both side, RSR seal, relubrication

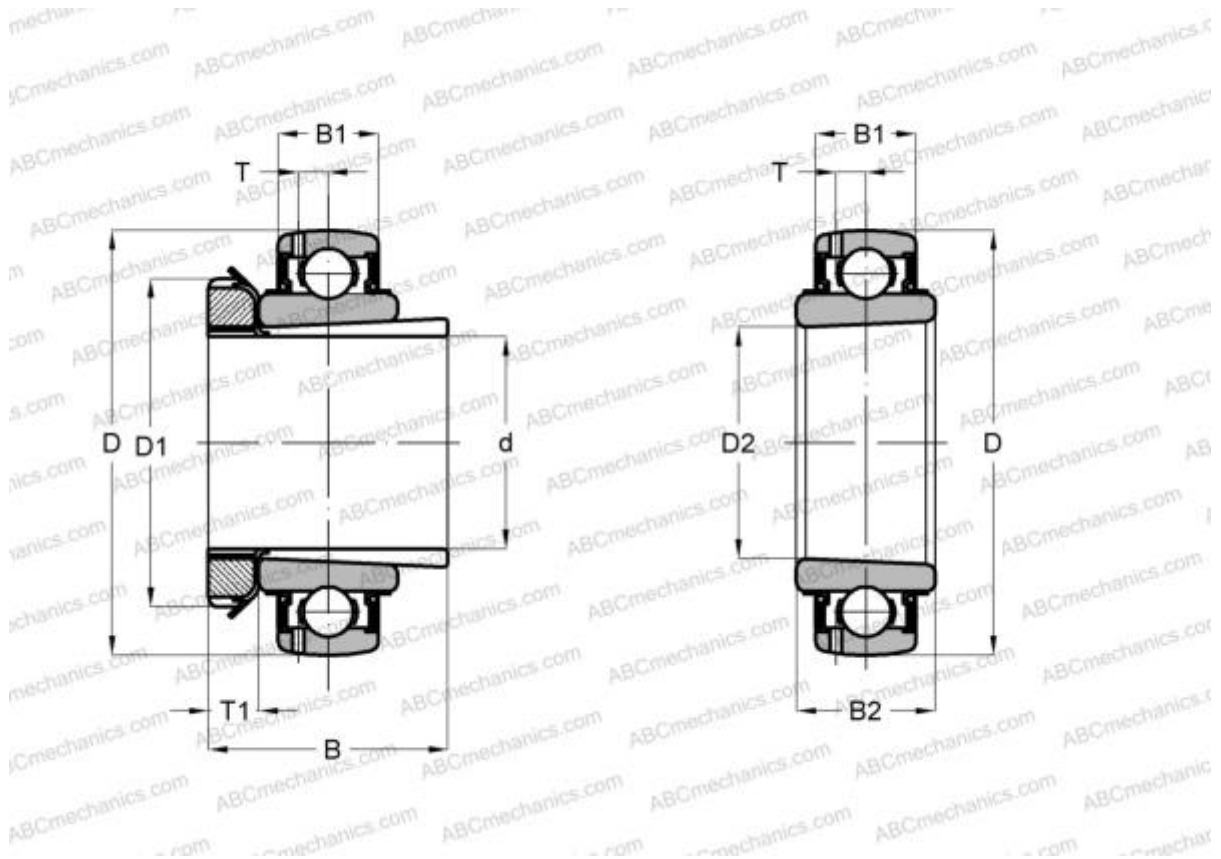

Technical specification

DIMENSIONS, MM

d	35,000
D	80,000
D1	58,000
D2	40,000
B	46,000
B1	21,000
B2	29,000
T	6,200
T1	10,000

MANUFACTURER [NTN](#)

INTERCHANGE

ABC	UK 208 + H2308
SKF	YSA 208-2FK
ASAHI	UK 208 + H2308

INTERCHANGE

FKL	LK 208 2F
SNR	UK208+H
SLB	UK208
FYH	UK 208