

## ZZ6202PP RINGSPANN

Freewheel

TYPE: Freewheel, Combined bearing/freewheel, Integral bearing based on series 62, 60, Keyway on both the inner and outer race

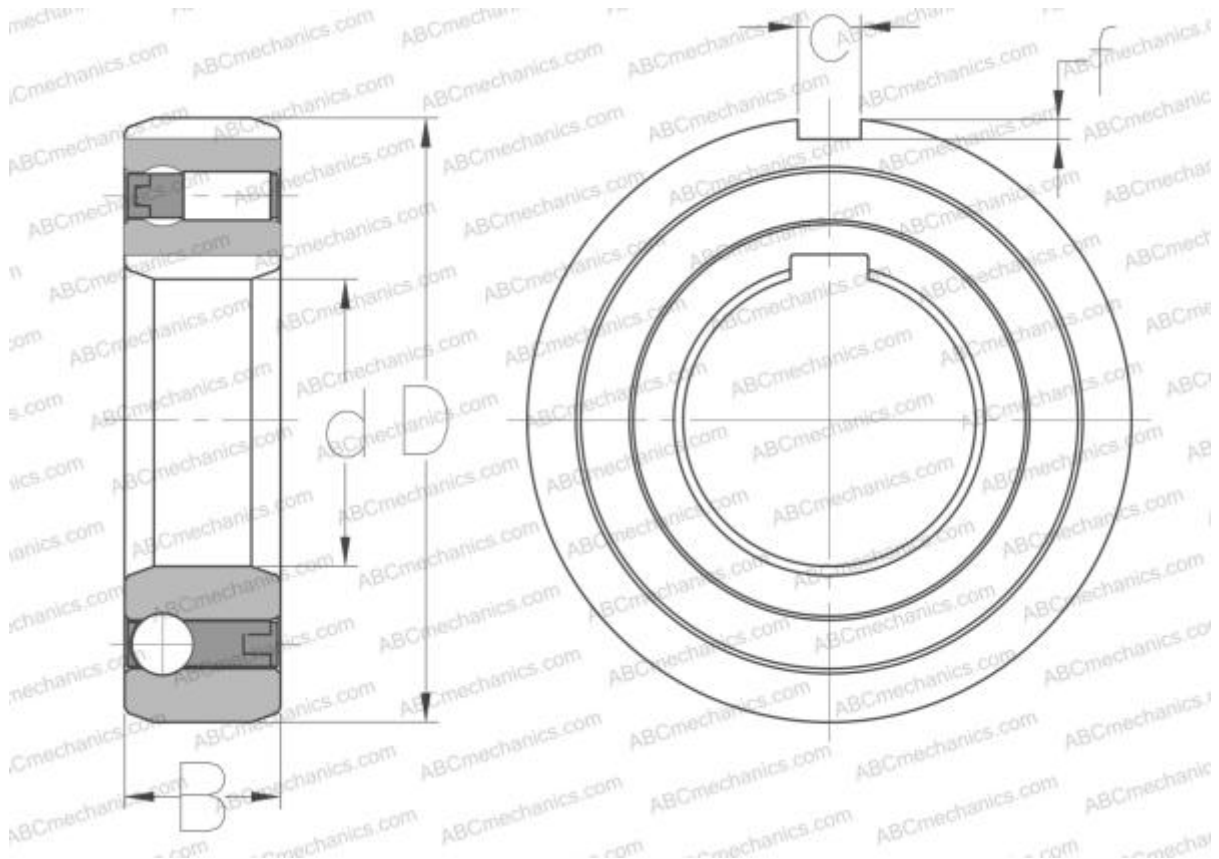

### Technical specification

#### DIMENSIONS, MM

d	15,000
D	35,000
B	11,000
f	0,600
c	2,000

#### MANUFACTURER

[RINGSPANN](#)

#### INTERCHANGE

ABC	<a href="#">CSK 15-PP</a>
STIEBER	<a href="#">CSK 15-PP</a>
TSUBAKI	<a href="#">BB15-2K</a>
RENOLD	<a href="#">REUKCC15</a>
CROSS+MORSE	<a href="#">CKKNN15</a>
C.T.S.	<a href="#">UKCC15ZZ</a>