

CSK 17-PP STIEBER

Freewheel

TYPE: Freewheel, Combined bearing/freewheel, Integral bearing based on series 62, 60, Keyway on both the inner and outer race

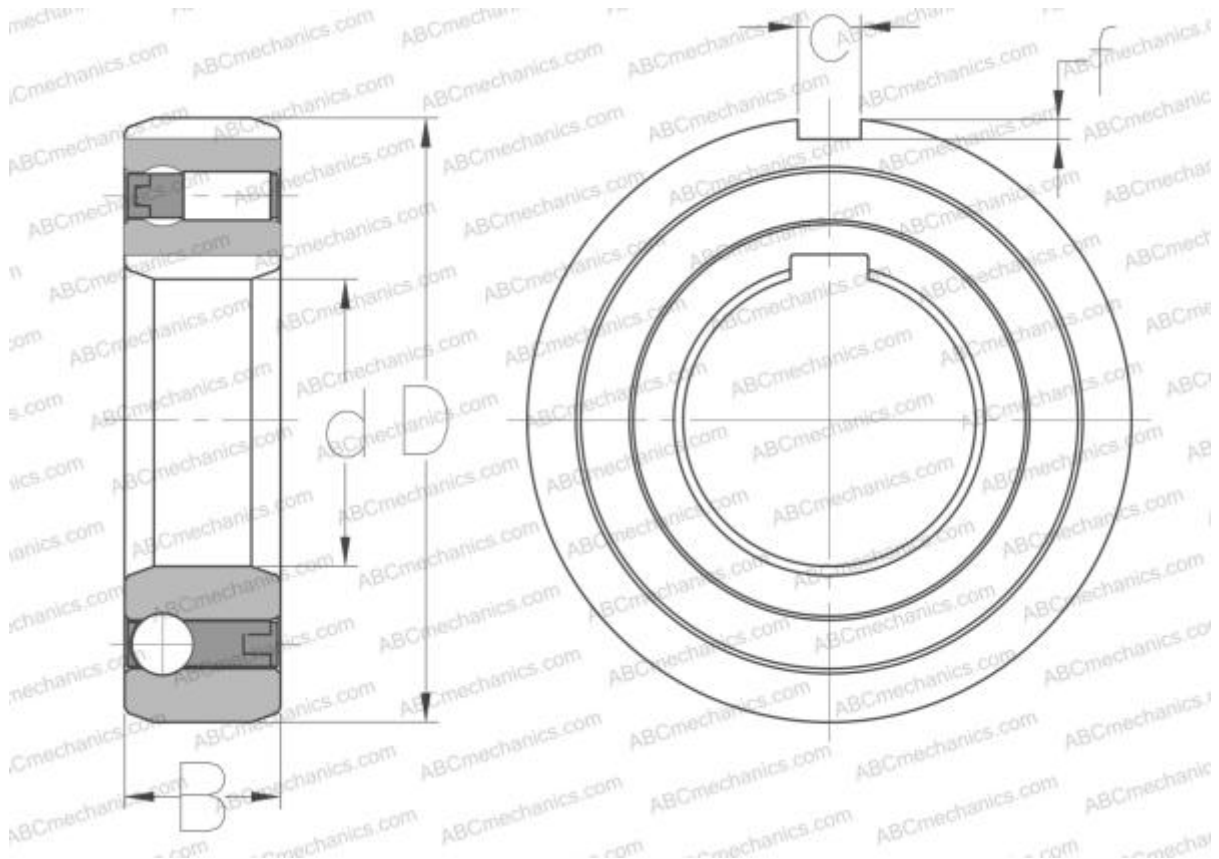

Technical specification

DIMENSIONS, MM

d	17,000
D	40,000
B	12,000
f	1,000
c	2,000

CALCULATION DATA

Basic dynamic load rating, C	7,900 kN
Basic static load rating, Co	3,800 kN

MANUFACTURER

[STIEBER](#)

INTERCHANGE

ABC	CSK 17-PP
TSUBAKI	BB17-2K
RINGSPANN	ZZ6203PP
RENOLD	REUKCC17
CROSS+MORSE	CKKNN17
C.T.S.	UKCC17ZZ