

NF 8 ABC

Freewheel

TYPE: Freewheel, Built-in freewheels, Wide serie

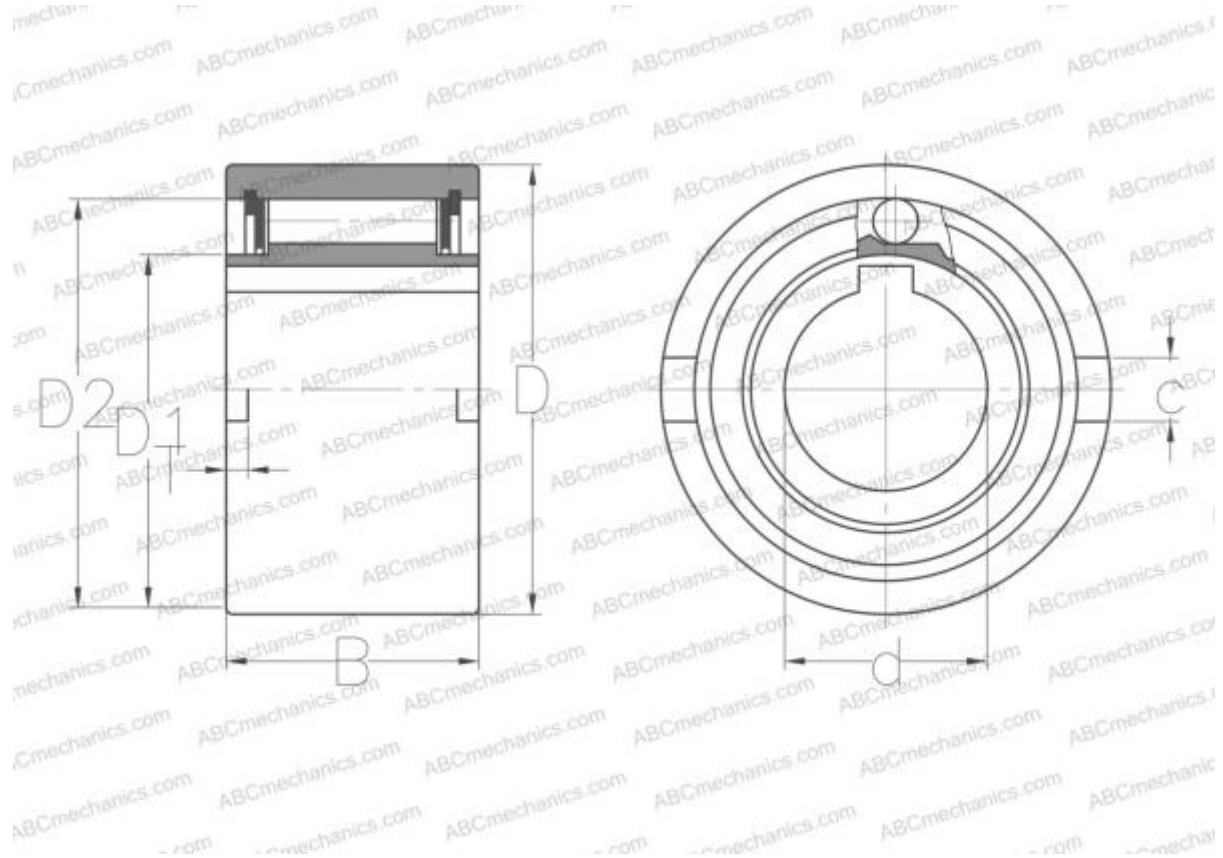

Technical specification

DIMENSIONS, MM

d	8,000
D	37,000
D1	20,000
D2	30,000
B	20,000
c	6,000
T	3,000

MANUFACTURER [ABC](#)

INTERCHANGE

STIEBER	NF 8
GMN	VF8
RINGSPANN	FN8
RENOLD	REUF8
C.T.S.	UF8